







GRAND WAGONEER

AUTOMAX
AUTOMAX



GRAND WAGONEER

AUTOMAX
AUTOMAX 23 418886077

GRAND WAGONEER



GRAND WAGONEER

AUTOMAX
AUTOMAX LLC 2018-2019-2020-2021-2022



GRAND WAGONEER



GRAND WAGONEER







GRAND WAGONEER

AIRBAG

Top View

START
ENGINE
STOP

Front Seats

Waterfall
High
Med
Low
On

GEAR
LIMIT

4. Navigation

P

128km

ED ↑

OFF

MAX WIPER

OFF

PREW WIPER

OFF

RES

SET-

SET+

CANC

OK

TRIP

TRIP

TRIP

TRIP

TRIP

TRIP

TRIP

TRIP

TRIP

TRIP

TRIP

TRIP

TRIP

TRIP

TRIP

TRIP

TRIP

TRIP

TRIP

TRIP

AM

AM

AM

AM

AM

AM

AM

AM

AM

AM

AM

AM

AM

AM

AM

AM

AM

AM

AM

AM

AM

AM

AM

AM

AM

AM

AM

AM

AM

AM

AM

AM

AM

AM

AM

AM

AM

AM

AM

AM

AM

AM

AM

AM

AM

AM

AM

AM

AM

AM

AM

AM

AM

AM

AM

AM

AM

AM

AM

AM

AM

AM

AM

AM

AM

AM

AM

AM

AM

AM

AM

AM

AM

AM

AM

AM

AM

AM

AM

AM

AM

AM

AM

AM

AM

AM

AM

AM

AM

AM

AM

AM

AM

AM

AM

AM

AM

AM

AM

AM

AM

AM

AM

AM

AM

AM

AM

AM

AM

AM

AM

AM

AM

AM

AM

AM

AM

AM

AM

AM

AM

AM

AM

AM

AM

AM

AM

AM

AM

AM

AM

AM

AM

AM

AM

AM

AM

AM

AM

AM

AM

AM

AM

AM

AM

AM

AM

AM

AM

AM

AM

AM

AM

AM

AM

AM

AM

AM

AM

AM

AM

AM

AM

AM

AM

AM

AM

AM

AM

AM

AM

AM

AM

AM

AM

AM

AM

AM

AM

AM

AM

AM

AM

AM

AM

AM

AM

AM

AM

AM

AM

AM

AM

AM

AM

AM

AM

AM

AM

AM

AM

AM

AM

AM

AM

AM

AM

AM

AM

AM

AM

AM

AM

AM

AM

AM

AM

AM

AM

AM

AM

AM

AM

AM

AM

AM

AM

AM

AM

AM

AM

AM

AM

AM

AM

AM

AM

AM

AM

AM

AM

AM

AM

AM

AM

AM

AM

AM

AM

AM

AM

AM

AM

AM

AM

AM

AM

AM

AM

AM

AM

AM

AM

AM

AM

AM

AM

AM

AM

AM

AM

AM

AM

AM

AM

AM

AM

AM

AM

AM

AM

AM

AM

AM

AM

AM

AM

AM

AM

AM

AM

AM

AM

AM

AM

AM

AM

AM

AM

AM

AM

AM

AM

AM

AM

AM

AM

AM

AM

AM

AM

AM

AM

AM

AM

AM

AM

AM

AM

AM

AM

AM

AM

AM

AM

AM

AM



AND WAGONEER

AIRBAG



SET+



CANC



RES



SET-

+
GEAR
LIMIT
-

START
ENGINE
STOP

- GEAR
LIMIT +



0

km/h



АУТОМАХ

1. Driver info

P

37°C

NW

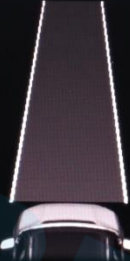

OFF RD



Driver Assist
Press Ok to Zoom In



1. Driver info



Hold OK for Digital

0

km/h
OK for MPH

Speedometer
80 km

P



OFF RD 2

ON OFF

OFF

OFF

NW

5. Off Road



AUTO

Automatic Full
Time 4WD
Adapts to
Road Conditions



P
OFF RD 2
Maximum
Ground Clearance

37°C



Terrain Status
80 km



4. Navigation

NW



P

37°C



OFF RD

80 km

E

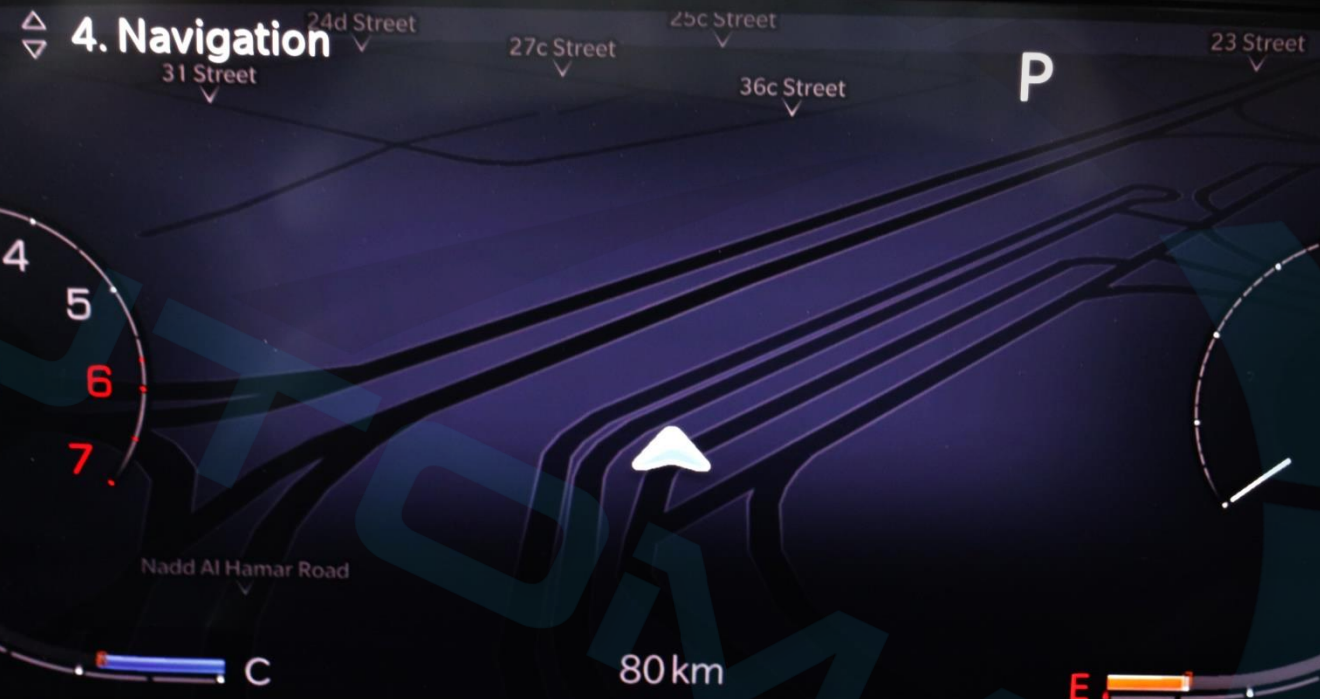

Check entire surroundings



Top View

Rear View

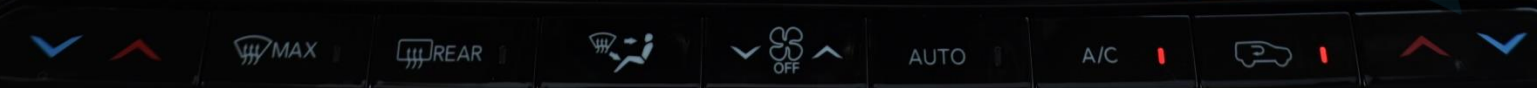

Select a seat to change zoom view



Volume control knob with VOL label and up/down arrows.

TUNE/SCROLL knob with up/down arrows and a power button icon.

Climate control panel with buttons for MAX, REAR, OFF, AUTO, A/C, and a car icon.

Search

Map interface with a search bar and a grid of street names. A blue arrow indicates the current location on the map.

HITFM
HITFM ARN NETWORK - 044...

All presets

Radio station interface for HITFM. It displays the station name and network information. Below the name are playback controls: a dropdown menu for 'All presets', and buttons for play/pause, previous track, and next track.

Phone

Select 'Add Device' to start the pairing process.

Add device Device Manager

Phone pairing interface. It prompts the user to select 'Add Device' to begin the pairing process. Two buttons, 'Add device' and 'Device Manager', are provided for selection.

Edit pages

VOL

Volume control knob with a 'VOL' label and up/down arrows.

TUNE SCROLL

Tune scroll knob with a 'TUNE SCROLL' label and left/right arrows.



Pitch Roll

1° 0°

Suspension

OFF RD 2

Edit pages

Home



NW



vol

TUNE SCROLL

LO [Icons] 1:34 FM HITFM [Icons] LO

Front Seats Massage Rear

Front defrost

Heat

Vent

Heat

Vent

Max A/C A/C Max Rear

Sync Off < 1 2 3 4 5 6 7 > Auto [Car Icon]



[Home] [Music] [Comfort] [NW A] [Phone] [Car] [Grid] [TUNE/SCROLL]



Wednesday, 2 October 2024 [Settings]

shortcuts
Icons to drag to status bar above

- [Icon]
- [Icon]
- [Icon]
- Sync

37°
OUT
Temperature

[Icon]
Profiles

[Icon]
Notifications

[Icon]
Fam Cam

[Icon]
Device Manager



LO [Icons] 1:34 [FM] HITFM [Icons] LO

Front **Seats** Massage Rear

- Lumbar Up/Down +		- Lumbar Up/Down +
- Lumbar In/Out +		- Lumbar In/Out +
- Back Bolster +		- Back Bolster +
- Thigh Bolster +		- Thigh Bolster +

Driver Psgr.

ZONE [Icons]

ZONE [Icons]

START ENGINE STOP

VOL [Up/Down]

Home Music Comfort NW A Phone Car App Grid

TUNE/SCROLL [Up/Down]

LO [Icons] 1:35 FM HITFM [Icons] LO

Front Seats **Massage** Rear

Waterfall

Lower back **High** High

Med Med

Extend Extend

Low Low

Low extend Low extend

Off Off

Rock climb Rock climb

Driver Psgr.

VOL [Knob] [Home] [Music] **Comfort** [NW] [Phone] [Car] [Grid] [TUNE/SCROLL] [Knob]

[Icons] MAX REAR [Icons] OFF AUTO A/C [Icons]

22.0° Front 22.0°

LO [Icons] 1:35 FM HITFM [Icons] LO

22° Front Seats Massage **Rear** 22°

Lock rear

→

↙

SYNC to driver Off < 1 2 3 4 5 6 7 > Auto

VOL [Knob] [Home] [Music] **Comfort** [NW] [Phone] [Car] [Grid] [TUNE SCROLL] [Knob]

[Vents] [MAX] [REAR] [OFF] [AUTO] [A/C] [Icons]

LO [Icons] 1:36 FM HITFM [Icons] LO

Off road | **Controls** | Settings

Mirror Dimmer	2nd row headrest fold	3rd row headrest fold
Pass screen Screen off	Passenger screen power off	Power Side Step
Surround camera	FamCam	Rear View camera

Home Music Activity NW A Phone Vehicle [Grid Icon]

[Icons] MAX REAR [Icons] OFF AUTO A/C [Icons]

LO [Icons] 1:36 FM HITFM [Icons] LO

Vehicle Dynamics

Steering Angle: 0°

Transfer Case: Unlocked

Rear Axle Locker: Unlocked

Suspension 4WD HIGH 55°21'60" E 25°10'07" N Altitude -26 m AUTO

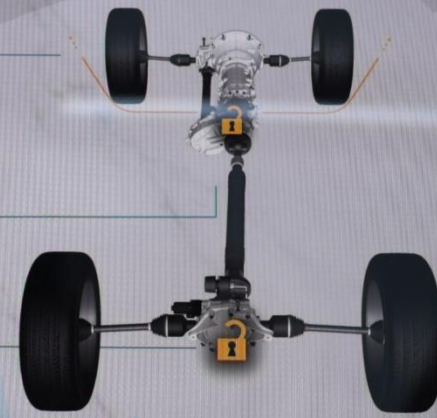

VOL

Home Music Phone NW A Vehicle [Grid]

TUNE/SCROLL

[MAX] [REAR] [Icons] [AUTO] [A/C]

Vehicle Dynamics

Accessory Gauges

Pitch & Roll

Selec-Terrain

Suspension

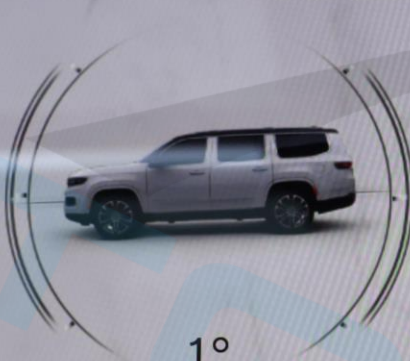

Pitch

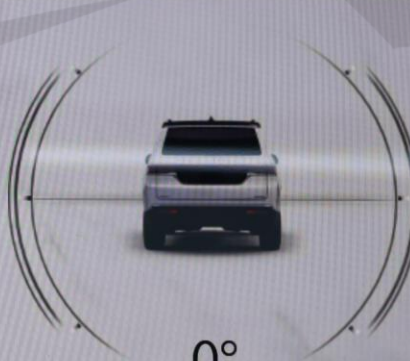

Roll

4WD HIGH 55°21'60" E 25°10'07" N Altitude -26 m AUTO



TUNE/SCROLL

Vehicle

LO 1:37 FM HITFM LO

Vehicle Dynamics

Accessory Gauges

Pitch & Roll

Selec-Terrain

Suspension



4WD HIGH 55°21'60" E 25°10'07" N Altitude -26 m AUTO



NW
A



Vehicle



TUNE/SCROLL



MAX

REAR



OFF

AUTO

A/C



- Automatic Emergency Braking >
- Display Active Lane Management >
- Entertainment screens ParkSense ⓘ Only warning Warning + braking assist
- My profile Front ParkSense Volume ⓘ Low Med High
- Safety & driving assistance Rear ParkSense Volume ⓘ Low Med High



LO [Icons] 13:38 FM HITFM [Icons] LO

Off road Controls Settings

Blind Spot Alert Off Lights Lights + chime

Electric power steering default Normal Sport Comfort

Power Side Step Auto Store

Hill Start Assist

Tire Fill Assist

Display

Entertainment screens

My profile

Safety & driving assistance



NW
A



Vehicle



TUNE/SCROLL

VOL



LO [Icons] 13:38 FM HITFM [Icons] LO

Favourites All

Media

Comfort

Nav

Phone

AM AM radio	Audio settings	Auxiliary cable	Bluetooth
DAB DAB	Device Manager	FM radio	Media

ZONE

[Icons]

ZONE

[Icons]

VOL

[Knob]

TUNE/SCROLL

[Knob]

[Home] [Music] [Phone] [NW] [Car] [Apps]

LO [Icons] 13:38 FM HITFM [Icons] LO

Favourites All

Media Comfort Nav Phone

DAB Device Manager FM Media

USB 1 USB 2

ZONE

VOL

ZONE

TUNE SCROLL

Home Music Sport NW A Phone Car Apps

Favourites

All

Media

Comfort

Nav

Phone



Comfort



Driver Heat



Driver Vent



Heated wheel



Massage seats



Psgr heat



Psgr vent



NW
A



Apps



AUTO

A/C



LO [Icons] 13:38 FM HITFM [Icons] LO

Favourites All

Media

Comfort

Nav

Phone

Android Auto

Device Manager

Phone

App icons: Home, Music, Phone, Navigation (NW), Car, Apps

ZONE

[Icons]

ZONE

[Icons]

VOL

[Knob]

TUNE/SCROLL

[Knob]

START ENGINE STOP

[Knob]

[Climate and Vehicle Control Icons]

LO [Icons] 13:39 FM HITFM [Icons] LO

Favourites All

- Phone
- Vehicle**
- System
- Other

Ambient Colour	Audio settings	Controls	FamCam
Mirror dimmer	Off Road Pages	Rear view camera	Select. tyre fill alert



Home Music Navigation (NW) Phone Vehicle Apps

MAX REAR [Icons] AUTO A/C [Icons]

Favourites All

Phone

Vehicle

System

Other



Driver profiles



Software updates



Stored Notificati...



NW
A



Apps



Favourites All

- Phone
- Vehicle
- System
- Other



McIntosh



Relax



Tutorials

ZONE [Icons]

VOL [Knob]

ZONE [Icons]

TUNE/SCROLL [Knob]

LO [Icons] 13:41 FM HITFM [Icons] LO

< Ambient Color Personalization

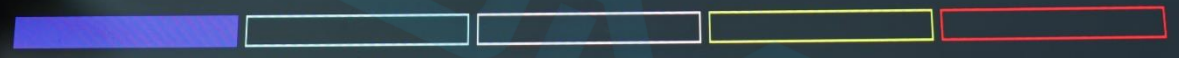
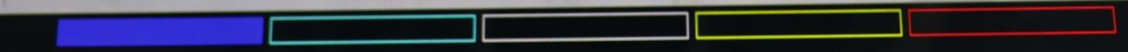

Показать весь доступный диапазон



Вид сверху

Вид сзади

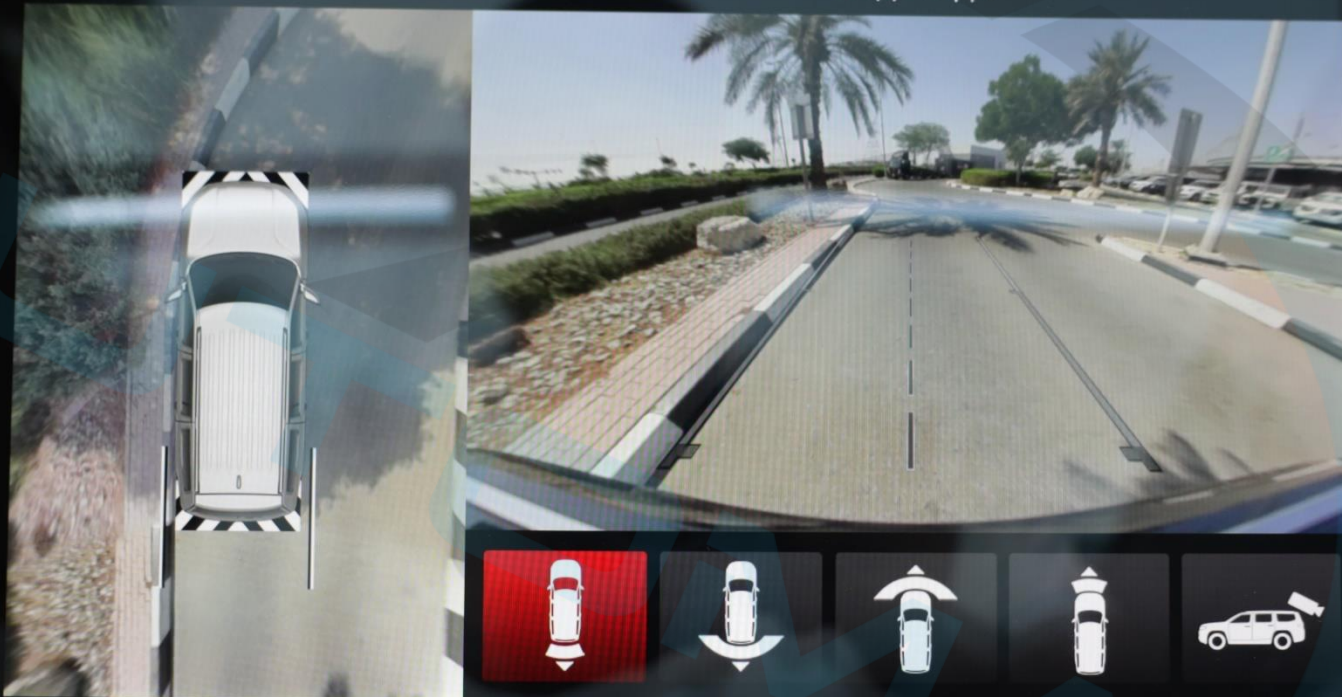

VOL

TUNE SCROLL

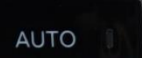

22.0°

Front

Seats

Massage

Rear

Screen Off

22.0°

Выбрать сиденье, чтобы изменить масштабированный вид

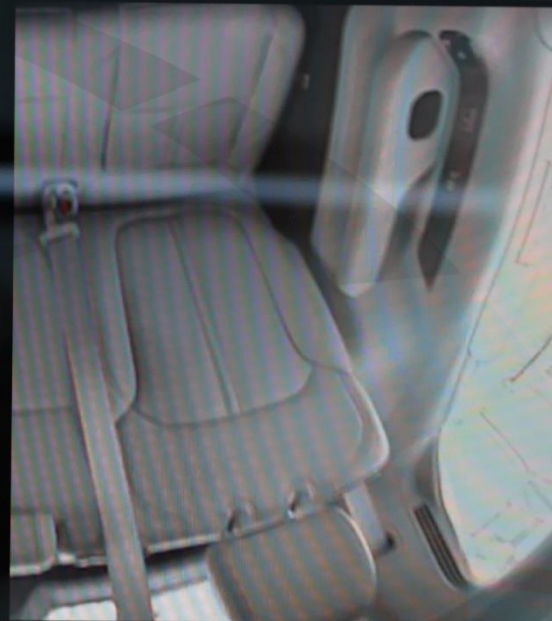

Управление климатом

↑&G

ZONE
*
⏻

↕
TUNE/
SCROLL

MAX REAR OFF AUTO A/C

Низ. | 13:48 HITFM | Низ.

Поиск Street

22 Street 25c Street 23 Street 13b Street
31 Street 27c Street 36c Street Nadd Al Hamar Road

3D

40

VOL

C3
▲
Nav

TUNE
SCROL

START
ENGINE
STOP

Наклон



1°

Крен

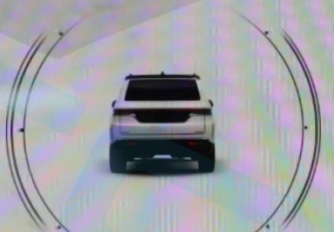

0°

Подвески

OFF RD 2



Редактировать страницы

Главная



C3
A



VOL

TUNE
SCROLL

Передн. Сиденья **Массаж** Задний

Расслабл.

Низ спины

Растягив.

Низ растягив.

Энергичный

Гром.

Сред.

Низ.

Off



Водит.



Пассаж.

Гром.

Сред.

Низ.

Off

Расслабл.

Низ спины

Растягив.

Низ растягив.

Энергичный



Comfort

C3



Низ. 13:47 FM HITFM Низ.

Передн. Сиденья Массаж Задний

Пер. обдув

Об. Вен

Макс. А/С A/C Максим. Задний

Синхр. Off 1 2 3 4 5 6 7 Авт.

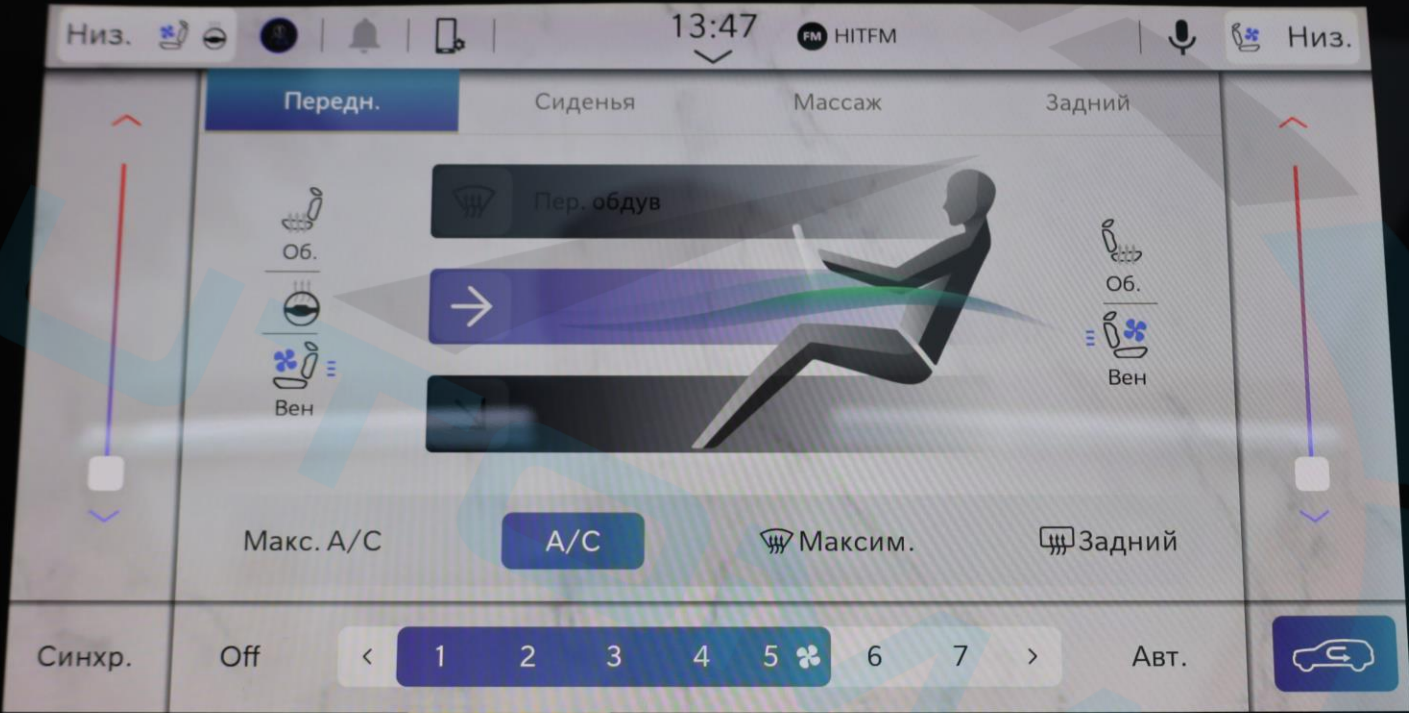

**Динамика
автомобиля**

Угол поворота
рулевого колеса:
0°

**Вспомог.
приборы**

Раздаточная
коробка:
Разблокирована

**Попер.
перемещения**

Selec-Terrain

Блокиратор
заднего моста:
Разблокирована

Подвески

4WD HIGH 55°21'60" В 25°10'07" С Высота -26 м AUTO

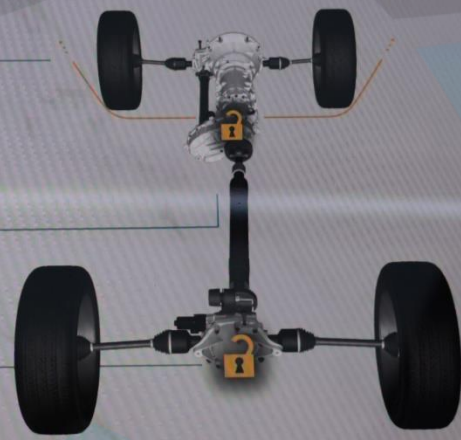

VOL
↑ ↓



C3
A



АВТОМ.



TUNE
SCROLL

تحقق من البيئة المحيطة بأكملها



الرؤية العلوية

الرؤية الخلفية

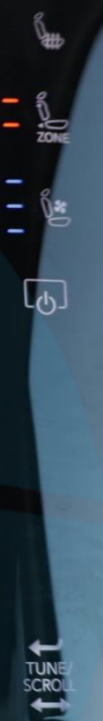
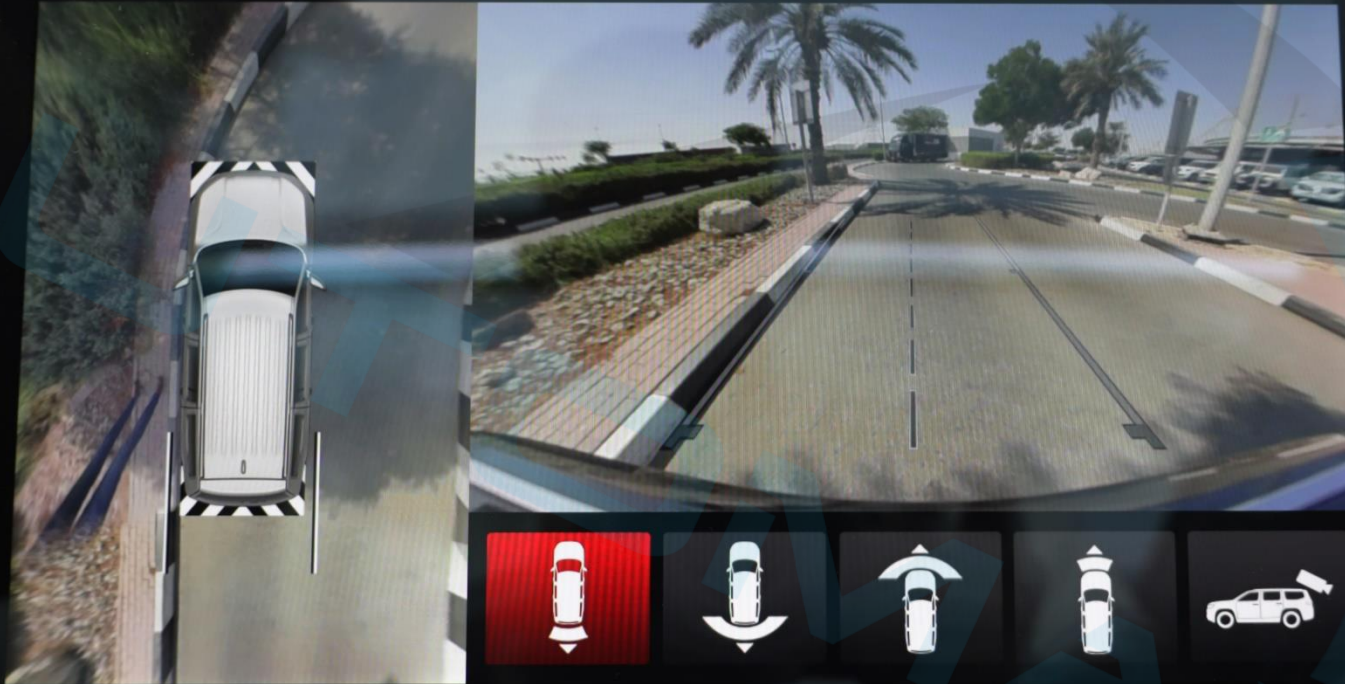

اختر مقعد لتغيير تكبير العرض



TUNE/SCROLL

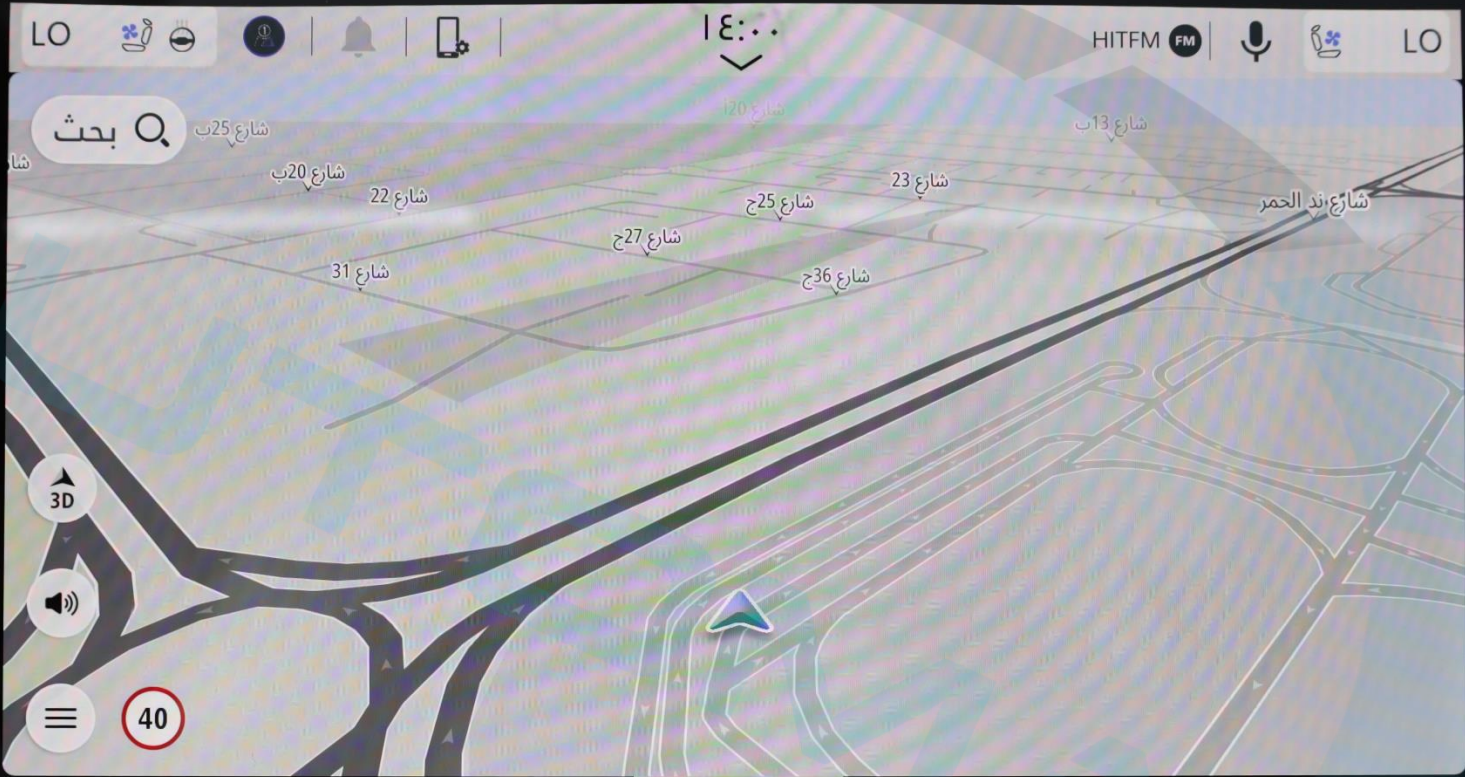

موسيقى
منازل
ZONE
منازل
موسيقى

موسيقى
منازل
ZONE
منازل
موسيقى

VOL

TUNE/SCROLL

START ENGINE STOP

MAX REAR

نظام التعليق

OFF RD 2



انحدار

1°

التفاف

0°



تحرير الصفحات

VOL [Volume Knob]



NW



الرئيسية

TUNE SCROLL [Tune Knob]

LO [Icons] 13:09 HITFM FM [Icons] LO

الأمامي المقاعد تدليك خلفي

إزالة الصقيع الأمامي

تسخين تبريد

تسخين تبريد

أقصى تكييف الهواء حد أقصى خلفي

مزامنة Off 1 2 3 4 5 6 7 ألي

ZONE

ZONE

VOL

TUNE/SCROLL

Comfort

LO | ١٤:٠٠ | HITFM FM LO

الاسترخاء | الأمامي | المقاعد | **تدليك** | خلفي | الاسترخاء

الاسترخاء

أسفل الظهر

تمديد

تمديد أسفل الظهر

شديد

عالي

متوسط

منخفض

Off

السائق

الراكب

عالي

متوسط

منخفض

Off

الاسترخاء

أسفل الظهر

تمديد

تمديد أسفل الظهر

شديد



NW
A



Comfort



TUNE/
SCROLL

LO | ١٤:٠٠ | HITFM FM LO

الأمامي المقاعد تدليك **خلفي**

٥٢٢ ٥٢٢

قفل الخلفي

المزامنة مع السائق Off < 1 2 3 4 5 6 7 > آلي

ZONE

ZONE

VOL

TUNE/SCROLL

NW

Comfort

LO



١٤:٠٦

HITFM FM



LO

ديناميكيات
المركبة

زاوية التوجيه:
0°

ملحقات
المقاييس

حالة النقل:
غير مغلق

انحدار و
التفاف

Selec-Terrain

قفل المحور
الخلفي:
غير مغلق

نظام التعليق

4WD
HIGH

55°21'60" E

25°10'07" N

ارتفاع -26 m

AUTO

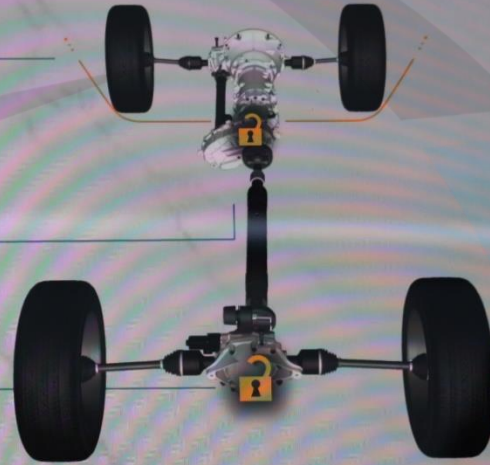

المركبة



NW
A



VOL

TUNE/
SCROLL



Тел.



АВТОМ.

Система

Navigation arrows, MAX, REAR, OFF, AUTO, A/C, and car icon buttons.

LO Front Seats Massage Rear Screen Off LO

Front Defrost

Sync Off 1 2 3 4 5 6 7 Max A/C

MUTE, AUTO HOLD ON, OFF, P ON, OFF, TOW/HAUL ON, and other vehicle function buttons.



MAX

REAR



AUTO

A/C



Front	Seats	Massage	Rear	Screen Off
<input type="button" value="-"/> Lumbar Up/Down <input type="button" value="+"/>	 <p>Driver</p>	 <p>Passenger</p>	<input type="button" value="-"/> Lumbar Up/Down <input type="button" value="+"/>	<input type="button" value="-"/> Lumbar Up/Down <input type="button" value="+"/>
<input type="button" value="-"/> Lumbar In/Out <input type="button" value="+"/>			<input checked="" type="button" value="-"/> Lumbar In/Out <input checked="" type="button" value="+"/>	<input type="button" value="-"/> Lumbar In/Out <input type="button" value="+"/>
<input checked="" type="button" value="-"/> Back Bolster <input checked="" type="button" value="+"/>			<input type="button" value="-"/> Back Bolster <input type="button" value="+"/>	<input type="button" value="-"/> Back Bolster <input type="button" value="+"/>
<input type="button" value="-"/> Thigh Bolster <input type="button" value="+"/>			<input type="button" value="-"/> Thigh Bolster <input type="button" value="+"/>	<input type="button" value="-"/> Thigh Bolster <input type="button" value="+"/>



MUTE



OFF

AUTO HOLD ON



OFF



OFF

ON

OFF

TOW HAUL ON



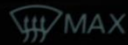

AUTO

A/C



Front Seats Massage Rear Screen Off

Waterfall	High	<p>Driver</p>	<p>Passenger</p>	High	Waterfall
Lower Back	Med			Med	Lower Back
Extend	Low			Low	Extend
Low Extend	Off			Off	Low Extend
Rock Climb					Rock Climb



MUTE



AUTO HOLD ON



P ON



TOW/HAUL ON



P

Home



Controls

Vehicle cameras

Fam Cam

Rear View

Check entire surrounding

Top View

Rear View

Surround View

AND WAGON

Home

Controls

Audio 

 Bluetooth

 FM

 AM

More...

Video 

 USB 1

 USB 2

More...

HDMI 

HDMI
HIGH DEFINITION MULTIMEDIA INTERFACE

Connect HDMI cable

Home



Controls

Navigation



Search



Favourites

Recent

Devices



0 devices connected



Pair new device



Manage Bluetooth headphones

Cameras



View vehicle
Camera apps



W A G O

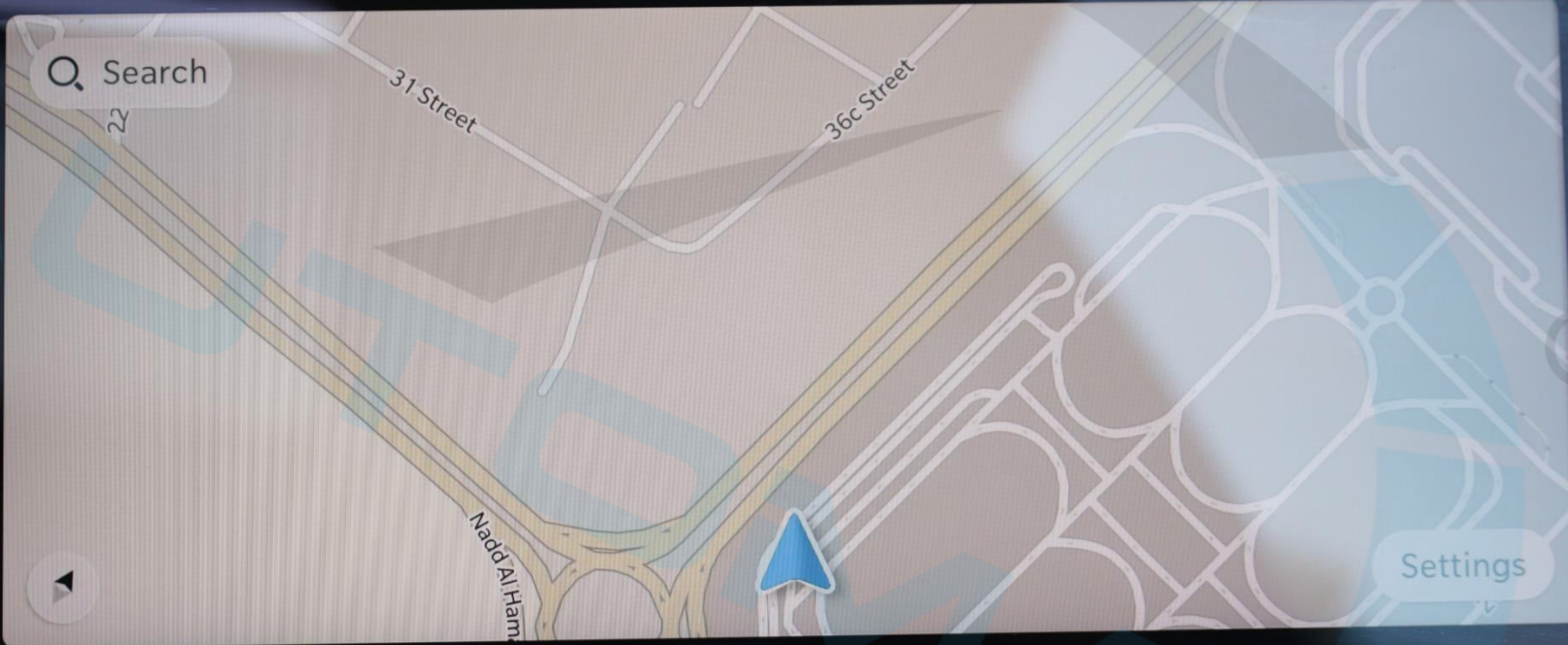

Home



Controls



Settings

C R A N D W A G O N



Sync

Off

1

2

3

4

5



6

7

Max A/C



MUTE



OFF

AUTO
HOLD
ON



OFF



OFF



ON



OFF

TOW/
HAUL
ON



P R N D

ROCK
SAND/MUD
SNOW
AUTO
SPORT



Sync Off 1 2 3 4 5 6 7 Max A/C

MAP AUTO OFF AUTO HOLD ON L4 OFF TRIP OFF PWR ON PWR OFF TOW/HACE ON

P R N D

ROCK
SAND/MUD
SNOW
AUTO
SPORT

←
|
|
|
|
→

4WD
LOW

4x4

4N



22.0°

Rear Comfort

Screen Off

22.0°

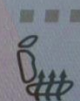
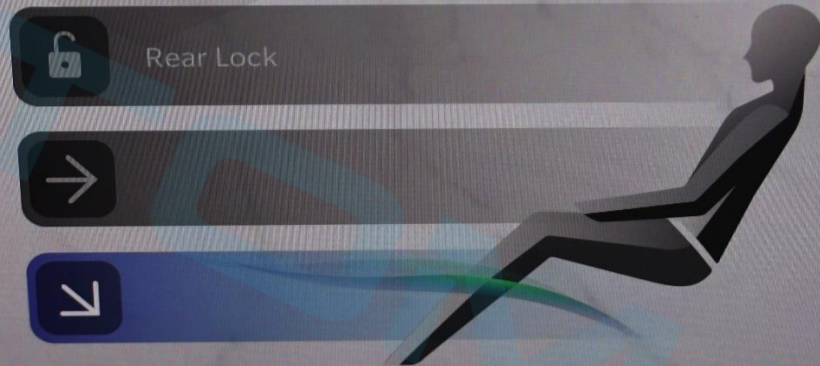
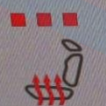

Sync

Off

1

2

3

4



5

6

7

Auto

230 V AC
150 W



12V DC



GRAND WAGONEER













OFF

ON



OPEN



CLOSE

TILT



DOWN

OPEN



CLOSE

AUTO

AUTO



START
ENGINE
STOP

RUN

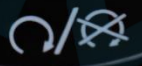





12V DC





AUTO

D

R



(P)

PULL ON





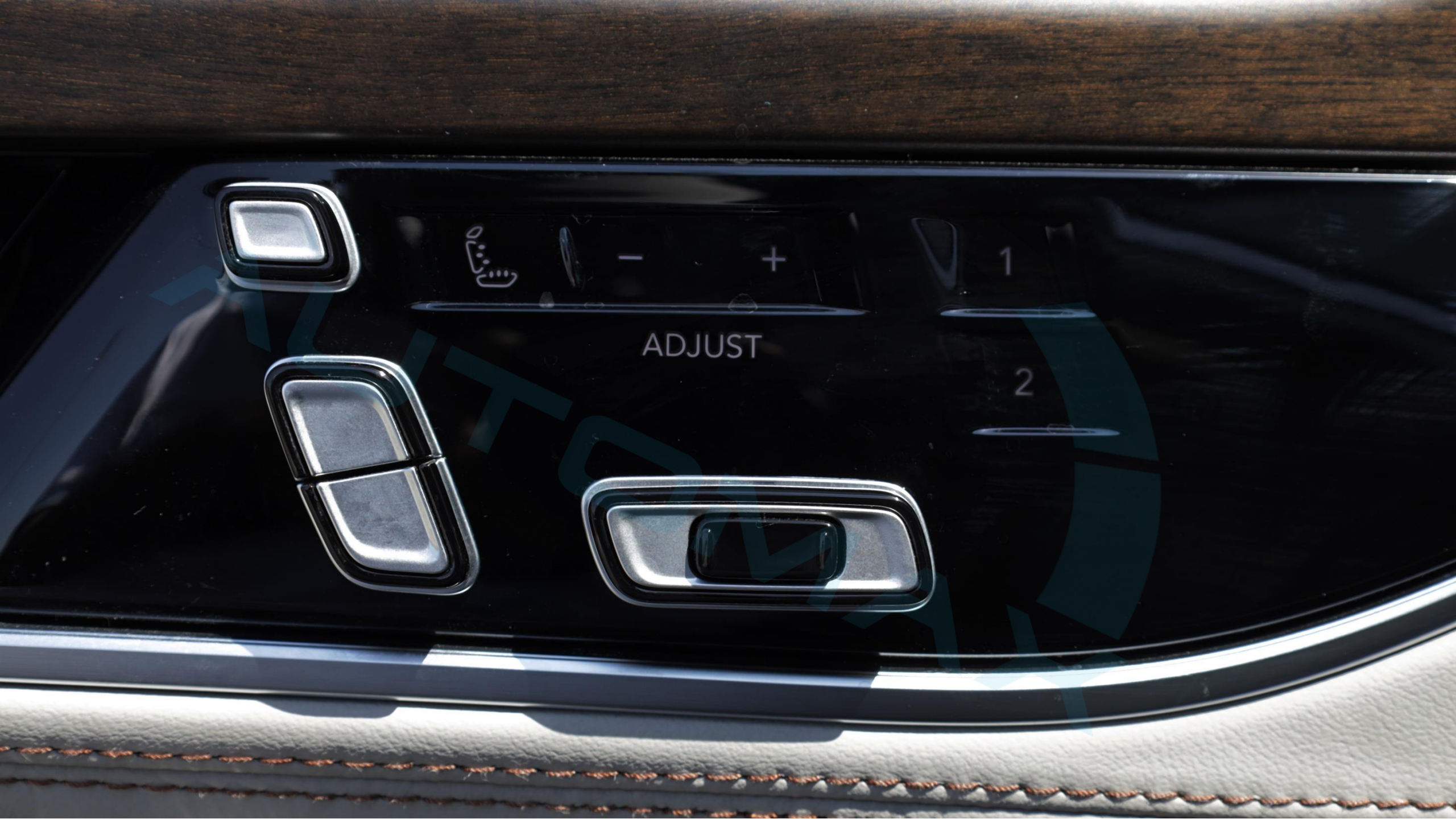

ADJUST

1

2



McIntosh





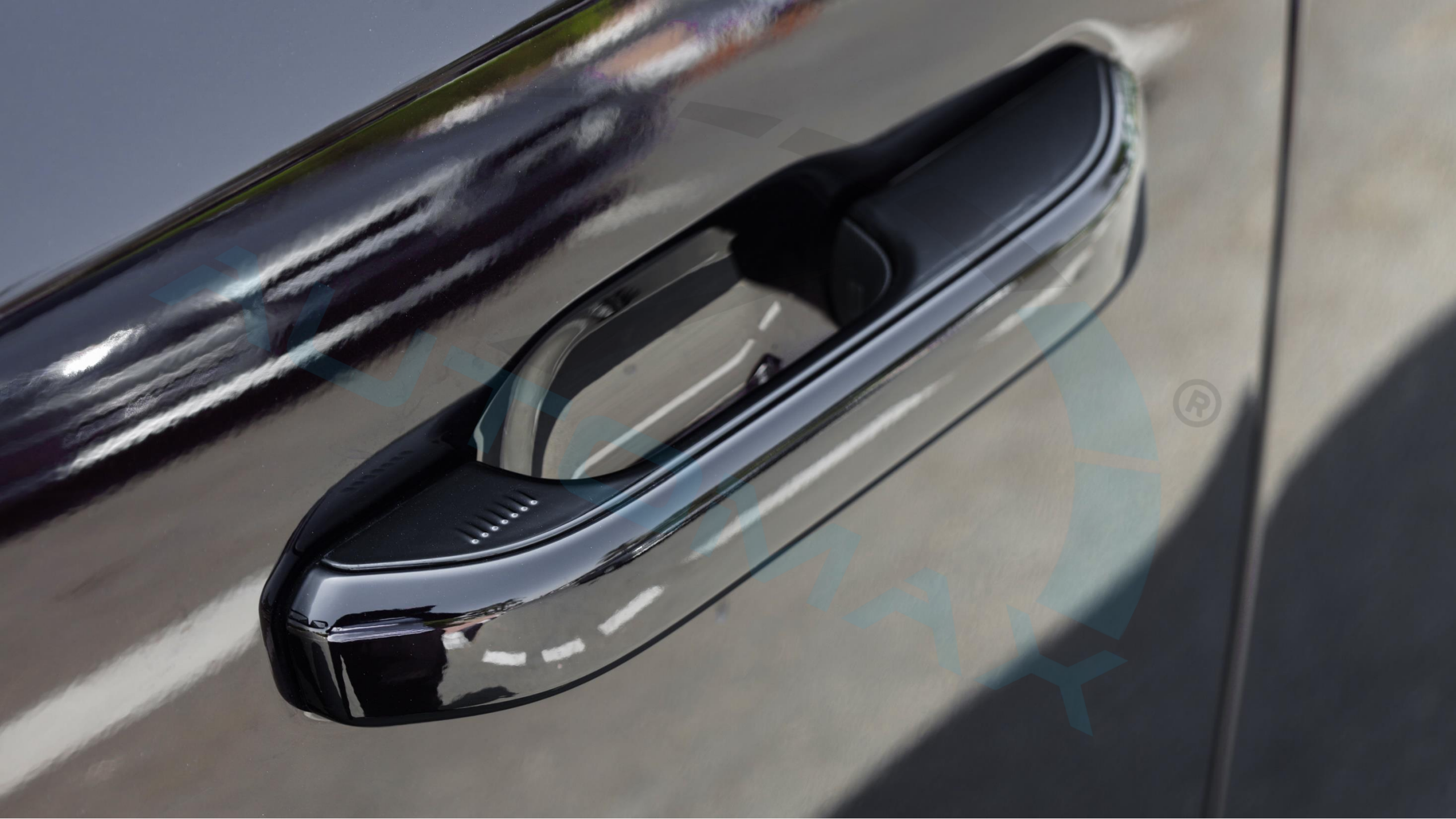





AUTODINAMIX

P

30340
68400498AA









GRAND WAGONEER



GRAN

DUELER

H/L AENZA

BRIDGESTONE





لمشاهدة صورة السيارة بزاوية 360 درجة إضغط على الصورة أعلاه

Для просмотра автомобиля в формате 360°, пожалуйста, нажмите на фото выше.

To view the 360° degree please press on the picture above

2023 JEEP GRAND WAGONEER SERIES II 16 3.0L TT 4X4 GCC 0Km

Бренд: Jeep

Brand: Jeep

الماركة: جيب

Категория: GRAND WAGONEER

Category: GRAND WAGONEER

الفئة: GRAND WAGONEER

Модель: SERIES II LUXURY

Model: SERIES II LUXURY

الموديل: SERIES II LUXURY

Год: 2023

Year: 2023

السنة: 2023

Километров: 0 Km

Kilometers: 0 Km

كيلومترات: 0 كم

Двери: 4 Doors

Doors: 4 Doors

عدد الأبواب: 4 أبواب

Цвет: Ember Pearl

Color: Ember Pearl / Sea Salt

اللون: Ember Pearl

Цилиндр: 6

Cylinder: 6 Cylinders

عدد الأسطوانات: 6 أسطوانات

Лошадиные силы: 510 HP

Horsepower: 510 HP

عدد الأحصنة: 510 حصان

Трансмиссия: Автоматическая

Transmission: Automatic

نوع النقل: نقل أوتوماتيكي

Топливо: Бензин

Fuel: Gasoline

نوع الوقود: بنزين

4X4

4X4

4X4

GCC

المواصفات خليجية

2023 JEEP GRAND WAGONEER SERIES II 16 3.0L TT 4X4 GCC 0Km

LEATHER TRIMMED BUCKET SEATS
SEA SALT/BLACK
MIDDLE EAST EQUIPMENT GROUP
OFF ROAD GROUP II
FLEXIBLE SEATING GROUP
AUX BATTERY
40/20/40 2ND ROW BENCH PWR TIP/SLIDE
REMOVABLE ASH TRAY
8 PASSENGER SEATING
8-SPD AUTO 8HP75 TRANS (BUY-US)
3.0L 16 HURRICANE HO TWIN TURBO ESS
AUTO DIM EXTERIOR DRIVER MIRROR
CIGAR LIGHTER
GPS NAVIGATION
GPS ANTENNA INPUT
ACTIVE NOISE CONTROL SYSTEM
EXT. MIRRORS W/SUPPLEMENTAL SIGNALS
EXTERIOR MIRRORS W/ARABIC LETTERING
EXTERIOR MIRRORS W/MEMORY
AUTO ADJUST IN REVERSE EXT MIRRORS

HEATED EXTERIOR MIRRORS
EXTERIOR MIRRORS APPROACH LAMPS
BLACK ROOF
QUADRA DRIVE II BADGE
U.S. EMISSIONS W/OBD I
INTEGRATED TIRE COMPRESSOR KIT
EMBER PEARL COAT
ALL RADIO EQUIPPED VEHICLES
12.0" TOUCHSCREEN DISPLAY
FRONT PASSENGER INTERACTIVE DISPLAY
2ND ROW DUAL CHG-ONLY USB PORTS
DIGITAL AUDIO BROADCASTING
ALL R1 HIGH RADIOS
BRIDGESTONE BRAND TIRES
ALL ALUMINUM WHEELS
FUEL TANK SKID PLATE SHIELD
TRANSFER CASE SKID PLATE SHIELD
FRONT AXLE SKID PLATE
STOP-START DUAL BATTERY SYSTEM
10 ADDITIONAL GALLONS OF GAS

2023 JEEP GRAND WAGONEER SERIES II 16 3.0L TT 4X4 GCS OKm

Quadra Drive II

INTEGRATED TIRE COMPRESSOR KIT

ADJUSTABLE ROOF RAIL CROSSBARS

8 местный

Зимний Пакет

Gear Limit

Вентиляция Сидений

Подогрев Сидений

Сиденья с функцией массажа

Рулевое Колесо с Подогревом

Регулируемые Сиденья с Памятью Позций

Дистанционный Запуск Двигателя

Система Мониторинга Слепых Зон

Бесключевой Доступ

Регулировка Режимов Вождения

Подрулевые Лепестки

Пневмоподвеска

Дистанционное управление пневмоподвеской

Адаптивный Круиз-контроль

ДИСПЛЕЙ ДЛЯ ПАССАЖИРА

Камера Наблюдения Внутри Салона

Холодильник

Контурная Подсветка Салона

Система Экстренного Торможения

Контроль Полосы Движения

Проекция на лобовое стекло

MCINTOSH Премиальная Мультимедийная Система С 19-МИ ДИНАМИКАМИ

Камера 360 Градусов

Панорамная Крыша

Беспроводная Зарядка

Система Помощи При Спуске с Горы

Датчик Давления в Шинах

Розетка

Задние Шторки

Система «Старт-Стоп»

Выдвижная Боковая Подножка

Автопарковка

R 20"

Apple Carplay + Android Auto

2023 JEEP GRAND WAGONEER SERIES II 16 3.0L TT 4X4 GCC 0Km

* الأداء:

ناقل حركة أوتوماتيكي ب 8 سرعات

عدد الأسطوانات: 6 أسطوانات

سعة المحرك: 3.0 توين توربو

العزم: 677 نيوتن.متر

عدد الأحصنة: 510 حصان

دفع رباعي 4X4

* المواصفات الإضافية:

Quadra Drive II

Gear Limit

INTEGRATED TIRE COMPRESSOR KIT

ADJUSTABLE ROOF RAIL CROSSBARS

8 مراتب

كاميرا بزاوية 360 درجة

شاشة بروجكتر أمامي

شاشة إضافية للمرافق

ثلاجة أمامية

عداد ديجيتال

مثبت السرعة التكميلي

نظام الهيدروليك لرفع و خفض المركبة مع خاصية التحكم عن بعد

نظام صوتي متقدم من MCINTOSH مع 19 سماعة

خاصية التبريد والتدفئة للمراتب

خاصية المساج للمراتب

فتحة سقف بانوراما مزدوجة

خاصية تثبيت المسار

كاميرا داخلية بزاوية 180 درجة

نظام الملاحة وتحديد المواقع

2023 JEEP GRAND WAGONEER SERIES II 16 3.0L TT 4X4 GCC 0Km

خاصية الكشف عن النقطة العمياء

أوتو بارك

التشغيل عن بعد

دخول بصمة

خاصية تدفئة المقود

خاصية المساعدة في نزول المنحدرات

نظام البطارية المزدوجة للبدء والتوقف

نظام مكابح متقدم مع الفرامل التلقائية

وضعية قيادة متعددة

مراتب كهربائية متعددة الوضعية مع خاصية الذاكرة

وحدة تكييف خلفية منفصلة

ابل كاربلاي لاسلكي

اندرويد أوتو لاسلكي

إنارة داخلية محيطيه

دبّة كهربائية مع حساس قدم

مخارج طاقة كهربائية متعددة

شاحن هاتف لاسلكي

ستائر خلفية

عتبات جانبية كهربائية

جنوط مقاس 20 بوصة

AUTOMAX®

The Boutique Of Muscle Cars, Truck Fanatics & German Automotive Experts.



تتکلم اللغة العربية

WE SPEAK ENGLISH

ON PARLE LE FRANCAIS

Nosotros hablamos español

мы говорим по-русски

biz o'zbek tilida

gaplashamiz

हम हिंदी बोलते हैं



automaxgroup.me



automax group



automax.dxb



Automax_LLC



+971 50 602 7200



automax.dxb



automax.dxb



automax.dxb



automax_dxb



automax group L.L.C

New Auto Market - Dubai - United Arab Emirates

 **Directions**