









Alain Class

GRAND WAGONEER

AUTOMAX

GRAND WAGONEER

مركز النور للسيارات
3 شارع النور

GRAND WAGONEER





GRAND WAGONEER



GRAND WAGONEER



Jeep
Mopar
Mopar
Mopar

Jeep
Mopar
Mopar
Mopar

FCA
FCA
FCA





GRAND WAGONEER

0 km/h P 26°C
Key Fob
has Left
the Vehicle

DO NOT PRESS

Top View

3

START ENGINE STOP

Front
Lumbar Up/Down
Lumbar In/Out
Back Bolster



GRAND WAGONEER

AIRBAG

↔ ID ↑ ↓

▲
◀ OK ▶
▼

📞

📻

📞

GRAND WAGONEER

AIRBAG
10

| | | |
|--|------|-----|
| | SET+ | |
| | CANC | RES |
| | SET- | |

+
GEAR

| | |
|-----|-----------|
| OFF | ON |
| | |
| OFF | REAR WASH |



0
km/h

AUTOMAXX

®



1. Driver Info

0

MPH

P

29°C

S



Night Vision



F



GRAND WAGONER



معلومات السائق 1.

0

MPH

P

29°



Night Vision

61 km

H



C

F

E

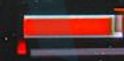

Check entire surroundings



Top View

Rear View

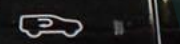
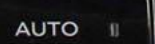
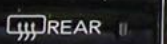

Select a seat to change zoom view

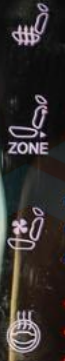

VOL

TUNE/SCROLL



Search



Low fuel. Find a gas station?

Yes

X

- Home
- Media
- Comfort
- Nav
- Phone
- Vehicle
- Apps

VOL

TUNE/SCROLL

Navigation and climate controls: MAX, REAR, OFF, AUTO, A/C

Front Seats Massage Rear

Heat Front Defrost

Heat

Vent

Heat

Vent

Max A/C A/C Max Rear

Sync Off < 1 2 3 4 5 6 7 > Auto

ZONE

[Icons]

ZONE

[Icons]

VOL

[Knob]

TUNE/SCROLL

[Knob]

LO



3:34

FM STAR FM



LO

Vehicle Dynamics

Steering Angle:
0°

Transfer Case:
Unlocked

Rear Axle Locker:
Unlocked

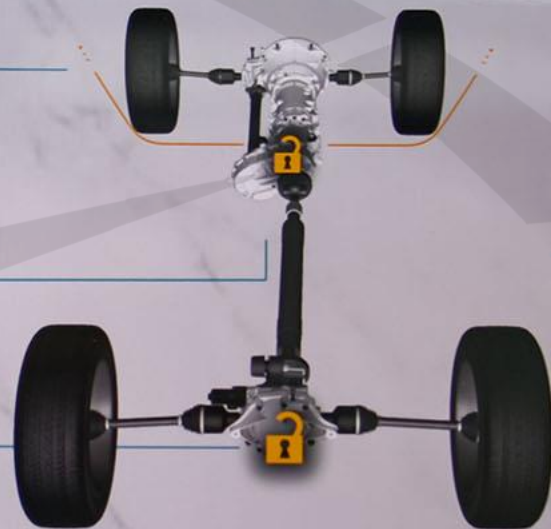

Accessory Gauges

Pitch & Roll

Selec-Terrain

Suspension

4WD
HIGH

55°22'35" E

25°10'04" N

Altitude -24 m

AUTO



Home



Media



Comfort



Nav



Phone



Vehicle



Apps



TUNE/
SCROLL

Vehicle Dynamics

Accessory Gauges

Pitch & Roll

Selec-Terrain

Suspension

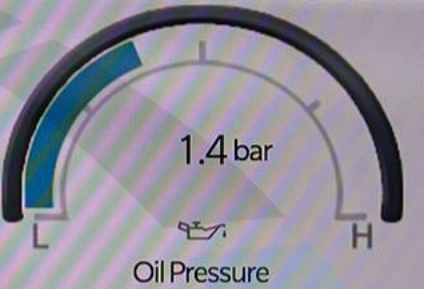

4WD HIGH 55°22'35" E 25°10'04" N Altitude -24 m AUTO

Home

Media

Comfort

Nav

Phone

Vehicle

Apps

TUNE/SCROLL

- Vehicle Dynamics
- Accessory Gauges
- Pitch & Roll**
- Selec-Terrain
- Suspension



1°

Pitch

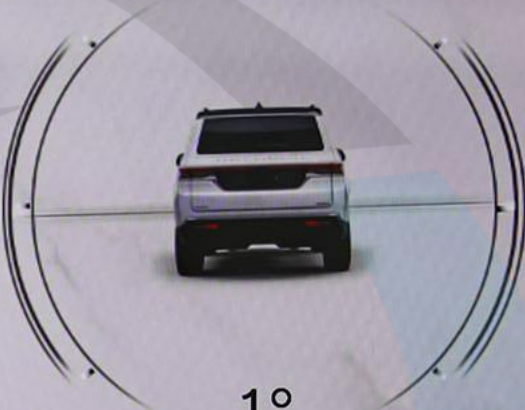

1°

Roll

4WD HIGH 55°22'35" E 25°10'04" N Altitude -24 m AUTO

ZONE

ZONE

VOL

TUNE/SCROLL

Vehicle Dynamics

Accessory Gauges

Pitch & Roll

Selec-Terrain

Suspension

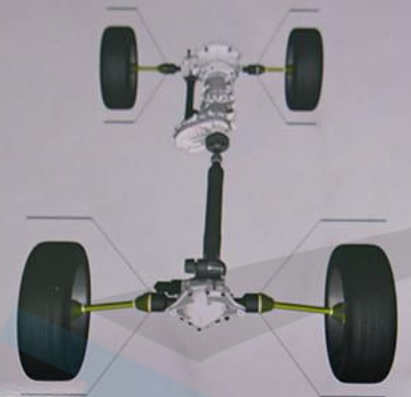

OFF RD 1

4WD HIGH

55°22'35" E

25°10'04" N

Altitude -24 m

AUTO



Home

Media

Comfort

Nav

Phone

Vehicle

Apps



AUTO

A/C

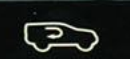

Vehicle Dynamics

Accessory Gauges

Pitch & Roll

Selec-Terrain

Suspension



4WD HIGH 55°22'35" E 25°10'04" N Altitude -24 m AUTO



Home



Media



Comfort



Nav



Phone



Vehicle



Apps



AUTO

A/C



McIntosh

REFERENCE

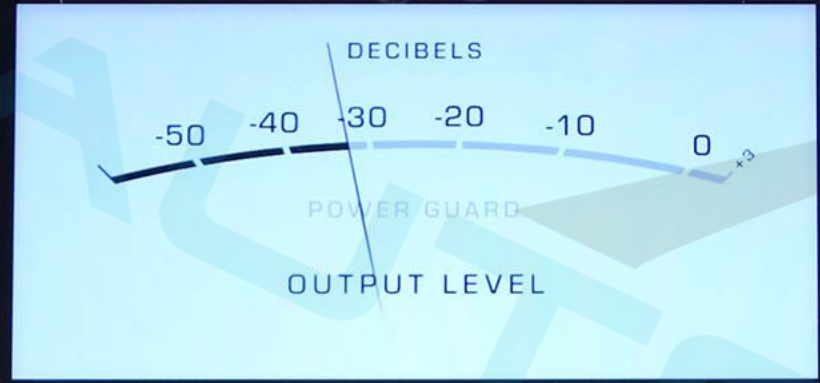

STAR FM

SMS: 3665 Phone: 600551211 twitter: @StarFMUAE insta...
99.9 FM

FM Radio

Audio

◀ CH

CH ▶

VOL

Home

Media

Comfort

Nav

Phone

Vehicle

Apps

TUNE/SCROLL

ZONE

ZONE

Favorites Recent Categories All

A-Z Z-A

☆
Tutorials

☆
Uconnect Theater

☆
USB 1

☆
USB 2

☆
Vehicle

☆
2nd Row Headrest...

☆
3rd Row Headrest...

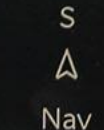

LO

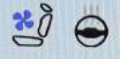

3:37

FM STAR FM



LO

Favorites

Recent

Categories

All

A-Z

Z-A



AM Radio



Ambient Color



Android Auto



Audio Settings



Auxiliary Cable



Bluetooth



Comfort

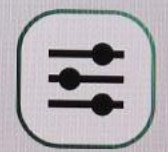

Controls



Home



Media



Comfort



Nav



Phone



Vehicle



Apps

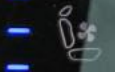

LO



3:37

FM STAR FM

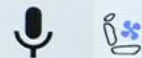

LO

Favorites

Recent

Categories

All

A - Z

Z - A



Tutorials



Uconnect Theater



USB 1



USB 2



Vehicle



2nd Row Headrest...



3rd Row Headrest...



Home



Media



Comfort



Nav



Phone



Vehicle



Apps

MAX

REAR

AUTO

AC

LO



3:37

FM STAR FM



LO



Selectable Tire Fill Alert



65.5



65.5



65.5

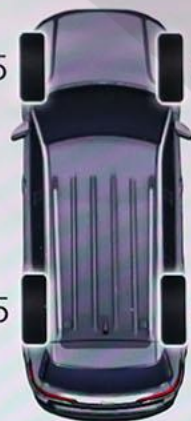

65.5

65.5

65.5

Apply and Save Preset

Presets



Home



Media



Comfort



Nav



Phone



Vehicle



Apps



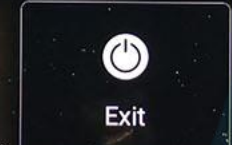
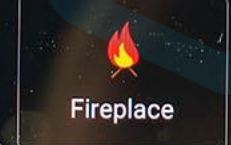
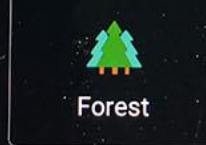

Front Seats Massage Rear Sun Off

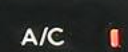
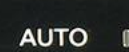
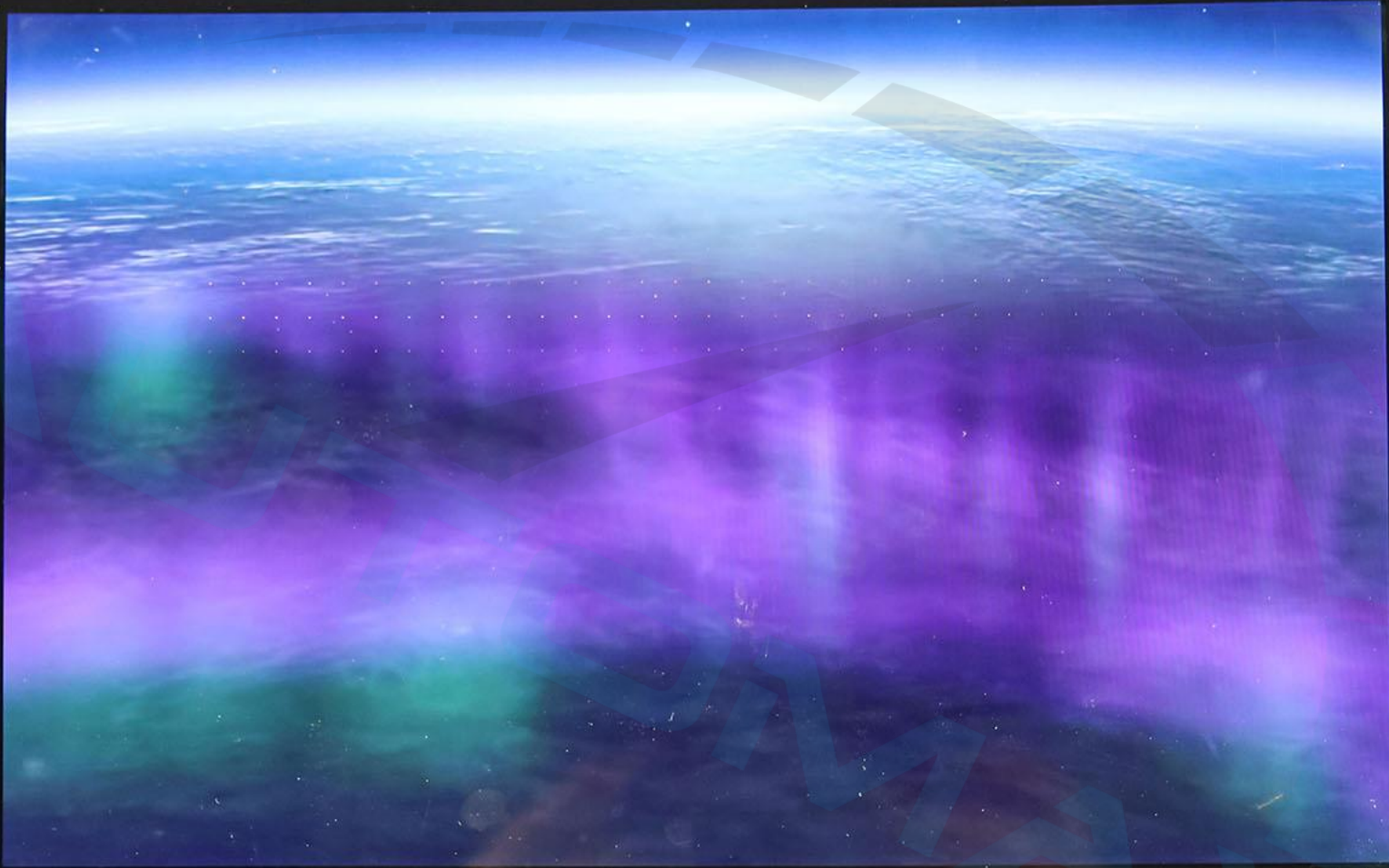



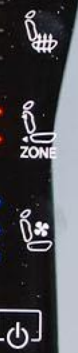

Передн. Сиденья Массаж Задний

Vertical slider with up and down arrows and a central square knob.

Пер. обдув

Об.

Вен

Макс. А/С

A/C

Максим.

Задний

Vertical slider with up and down arrows and a central square knob.

Синхр. Off < 1 2 3 4 5 6 7 > Авт.

Низ.

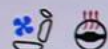

3:43

FM STAR FM



Низ.

Передн.

Сиденья

Массаж

Задний

Расслабл.

Расслабл.

Низ
спины

Гром.

Гром.

Низ
спины

Растягив.

Сред.

Сред.

Растягив.

Низ
растягив.

Низ.

Низ.

Низ
растягив.

Энергичный

Off

Off

Энергичный



Водит.



Пассаж.

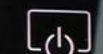
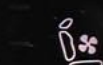

Главная



М/мед



Comfort



Nav



Тел.



Автом.



Прил.



TUNE/
SCROLL

Бездорожье

Элементы управления

Настройки

Затем. зер. зад. вида

Склад. подгол. 2 ряда

Склад. подгол. 3 ряда

Экран пассажира Выкл.

Экран пассажира Питание выкл.

Отказать в выдаче полномочи й экрану

Power Side Step

Кам. круг. обзора

FamCam

VOL

Главная

М/мед

Comfort

Nav

Тел.

Автом.

Прил.

TUNE/SCROLL

Низ.



3:42

FM STAR FM



Низ.

Избранные

Последние

Категории

Все



Off Road Pages



Device Manager



Android Auto



VOL



Главная



М/мед



Comfort



Nav



Тел.



Автом.



Прил.

TUNE/SCROLL

Низ.

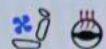

3:42

FM STAR FM



Низ.

Динамика
автомобиля

Вспомог.
приборы

Попер.
перемещения

Selec-Terrain

Подвески

Угол поворота
рулевого колеса:
0°

Раздаточная
коробка:
Разблокирована

Блокиратор
заднего моста:
Разблокирована

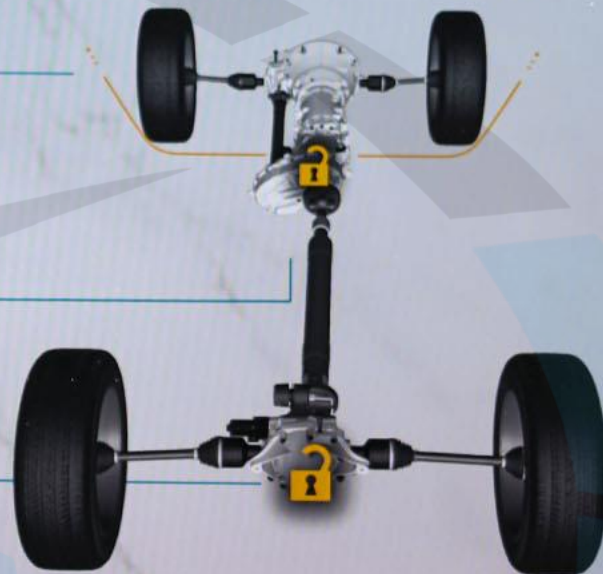

4WD
HIGH

55°22'35" В

25°10'04" С

Высота -24 м

AUTO



Главная



М/мед



Comfort



Nav



Тел.



Автом.



Прил.



TUNE/
SCROLL

Динамика
автомобиля

Вспомог.
приборы

Попер.
перемещения

Selec-Terrain

Подвески



4WD HIGH 55°22'35" В 25°10'04" С Высота -24 m AUTO

VOL

Главная

М/мед

Comfort

Ю А Nav

Тел.

Автом.

Прил.

TUNE/SCROLL

MAX REAR OFF AUTO A/C

Низ.



3:42

FM STAR FM



Низ.

Динамика
автомобиля

Вспомог.
приборы

Попер.
перемещения

Selec-Terrain

Подвески



1°

Наклон



1°

Крен

4WD
HIGH

55°22'35" В

25°10'04" С

Высота -24 м

AUTO



Главная



М/мед



Comfort



Nav



Тел.



Автом.



Прил.

TUNE/
SCROLL



Низ. | 3:42 | FM STAR FM | Низ.

Динамика автомобиля

Вспомог. приборы

Попер. перемещения

Selec-Terrain

Подвески

4WD HIGH 55°22'35" В 25°10'04" С Высота -24 m AUTO

OFF RD 1

VOL

Главная М/мед Comfort Ю А Nav Тел. Автом. Прил.

MAX REAR OFF AUTO A/C

ZONE

ZONE

TUNE/SCROLL

Низ.



3:42

FM STAR FM



Низ.

Ambient Color Personalization

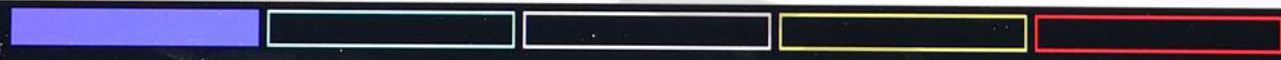

Син.

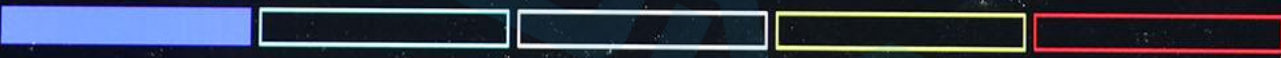

Главная

М/мед

Comfort

Ю
A
Nav

Тел.

Автом.

Прил.



الأمامي المقاعد تدليك خلفي

إزالة الصقيع الأمامي

تسخين مقود التوجيه عالية

تبريد

تسخين تبريد

أقصى تكييف

تكييف الهواء

حد أقصى

خلفي

مزامنة Off < 1 2 3 4 5 6 7 > ألي

مكشوف

ZONE

مكشوف

مكشوف

مكشوف

ZONE

مكشوف

مكشوف

VOL

التطبيقات

المركبة

الهاتف

S A Nav

Comfort

الوسائط

الرئيسية

TUNE/SCROLL

MAX REAR [Icons] AUTO A/C [Icons]

LO



٣:٤١

STAR FM

FM



LO

الأمامي

المقاعد

تدليك

خلفي

الاسترخاء

الاسترخاء

أسفل
الظهر

عالي

عالي

أسفل
الظهر

تمديد

متوسط

متوسط

تمديد

تمديد أسفل
الظهر

منخفض

منخفض

تمديد أسفل
الظهر

Off

Off

شديد

شديد



السائق



الراكب



التطبيقات



المركبة



الهاتف

S



Nav



Comfort



الوسائط



الرئيسية

TUNE/
SCROLL

LO



٣:٣٩

STAR FM FM



LO

ديناميكيات
المركبة

ملحقات
المقاييس

انحدار و
التفاف

Selec-Terrain

نظام التعليق

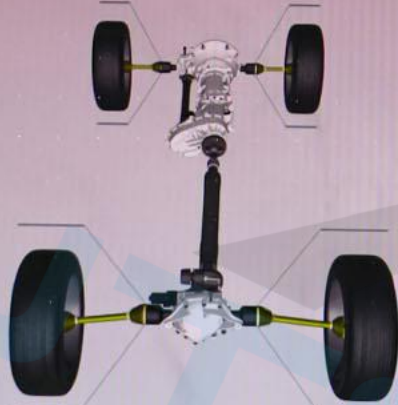

OFF RD 1

4WD
HIGH

55°22'35" E

25°10'04" N

ارتفاع -24m

AUTO

التطبيقات

المركبة

الهاتف

S
A
Nav

Comfort

الوسائط

الرئيسية

TUNE/
SCROLL



LO



٣:٣٩

STAR FM



LO

ديناميكيات
المركبة

ملحقات
المقاييس

انحدار و
التفاف

Selec-Terrain

نظام التعليق



4WD
HIGH

55°22'35" E

25°10'04" N

ارتفاع -24 m

AUTO

التطبيقات

المركبة

الهاتف

Nav

Comfort

الوسائط

الرئيسية

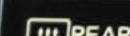
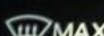

AUTO

A/C

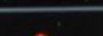

ديناميكيات
المركبة

ملحقات
المقاييس

انحدار و
التفاف

Selec-Terrain

نظام التعليق



1°

انحدار

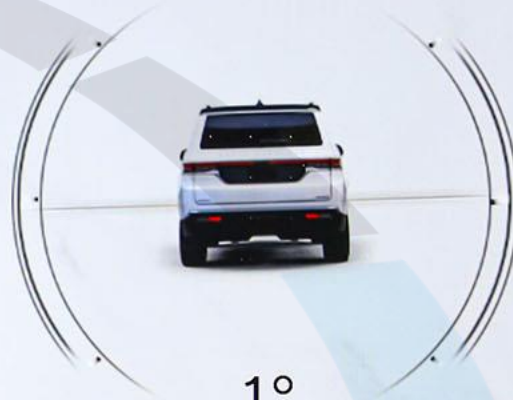

1°

التفاف

4WD
HIGH

55°22'35" E

25°10'04" N

ارتفاع -24 m

AUTO

التطبيقات

المركبة

الهاتف

Nav

Comfort

الوسائط

الرئيسية



LO



٣:٣٩

STAR FM FM



LO

ديناميكيات
المركبة

ملحقات
المقاييس

انحدار و
التفاف

Selec-Terrain

نظام التعليق

4WD
HIGH

55°22'35" E

25°10'04" N

ارتفاع -24 m

AUTO

VOL



التطبيقات



المركبة



الهاتف

S
A

Nav



Comfort



الوسائط



الرئيسية

TUNE/
SCROLL



الجميع الفئات الأخيرة المفضلة

ي-ا ي-ا

| | |
|--|---|
| ☆  طبي مسند رأس... ☆  طبي مسند رأس... ☆  FM راديو | ☆  AM راديو |
| ☆  لون المحيط الداخلي ☆  كاميرا الرؤية المحيطة ☆  كاميرا الرؤية الخلفية ☆  AUX كابل | |

التطبيقات المركبة الهاتف Nav Comfort الوسائط الرئيسية

VOL

TUNE/SCROLL

MAX REAR OFF AUTO A/C [Icons]

ديناميكيات
المركبة

ملحقات
المقاييس

انحدار و
التفاف

Selec-Terrain

نظام التعليق

زاوية التوجيه:
0°

حالة النقل:
غير مغلق

قفل المحور
الخلفي:
غير مغلق

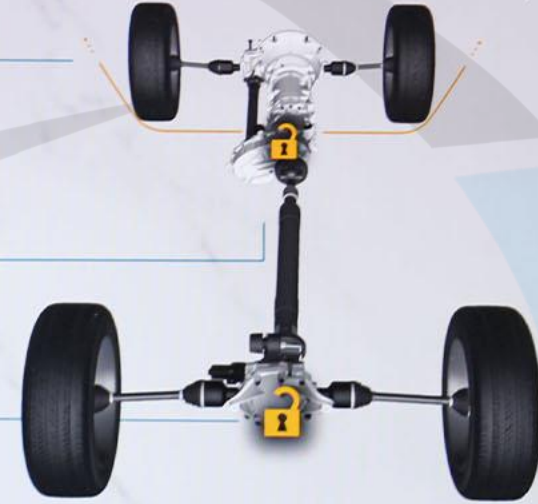

4WD
HIGH

55°22'35" E 25°10'04" N

ارتفاع -24 m

AUTO

VOL

التطبيقات

المركبة

الهاتف

S
A
Nav

Comfort

الوسائط

الرئيسية

TUNE/
SCROLL

LO



٣:٣٨

STAR FM FM



LO

أراض وعرة

متحكمات

إعدادات

طي مسند
الرأس للصف
الثالث



طي مسند
الرأس للصف
الثاني



معتم المرأة



منع أذونات
شاشة
الراكب



إيقاف
تشغيل
شاشة
الراكب



شاشة
الراكب
مطفأة



FamCam



كاميرا الرؤية
المحيطة



Power Side
Step



التطبيقات

المركبة

الهاتف

S
A
Nav

Comfort

الوسائط

الرئيسية



MAX

REAR



OFF

AUTO

A/C

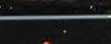

الجميع الفئات الأخيرة المفضلة

ي-١ ي-١

| | | | |
|------------------|------------------|-------------|-----------------|
| ☆ هاتف | ☆ ملفات تعريف... | ☆ مقود مدفأ | ☆ مقاعد التدليك |
| ★ Device Manager | ☆ DAB | ☆ Bluetooth | ★ Android Auto |

VOL

TUNE/SCROLL

LO



Off Road



Mirror Dimmer

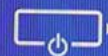

Pass Screen Off

Power Side





|   LO

Settings

rd Row
eadrest
old

eny Pass
creen
ermissions

 ZONE





LO [Icons] ٣:٣٩ STAR FM [FM] [Icons] LO

Ambient Color Personalization >

ZONE [Icons]

ZONE [Icons]



مزامنة

[VOL] [Icons]

التطبيقات

المركبة

الهاتف

Nav

Comfort

الوسائط

الرئيسية

[TUNE/SCROLL] [Icons]



GRAND WAGON

System



Screen Off



Power Off

Controls

Home



Controls

System



Screen Off

Power Off



Wireless Headphones



Manage Headphone

Mute



Navigation and climate control buttons: AUTO

Front Seats | Message | Rear | Screen Off

| | | | | | | | |
|--|----------------|--|--|--|----------------|--|--|
| | Lumbar Up/Down | | | | Lumbar Up/Down | | |
| | Back Bolster | | | | Back Bolster | | |
| | Thigh Bolster | | | | Thigh Bolster | | |

Driver | Passenger

MUTE OFF OFF OFF ON OFF

ROCK SAND/MUD SNOW AUTO SPORT

PRND

4WD LOW



Front Seats Massage Rear Screen Off

Lumbar Up/Down

Lumbar In/Out

Back Bolster

Thigh Bolster



Driver



Passenger

Lumbar Up/Down

Lumbar In/Out





Back Bolster

Thigh Bolster



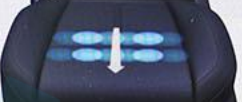
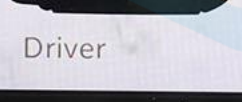
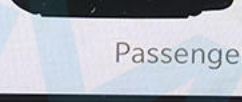

Front Seats Massage Rear Screen Off

| | | | | | |
|-------------------|-------------|--|---|-------------|------------|
| Waterfall | High |  |  | High | Waterfall |
| Lower Back | Med |  |  | Med | Lower Back |
| Extend | Low |  |  | Low | Extend |
| Low Extend | Off |  |  | Off | Low Extend |
| Rock Climb | | | | | Rock Climb |

Driver Passenger



ROCK

P R N D



LO Front Seats Massage Rear Screen Off LO

Front Defrost

1 2 3 4 5 6 7 Max A/C

The central display features a silhouette of a driver in a car seat. Three horizontal bars extend from the driver's seat area: a grey bar at the top labeled 'Front Defrost' with a wiper icon, a blue bar in the middle with a right-pointing arrow, and a grey bar at the bottom with a downward-pointing arrow. The bottom of the screen has a row of seven numbered buttons (1-7) and a 'Max A/C' button. The '5' button is highlighted in blue and contains a fan icon. On the left and right sides of the screen, there are vertical sliders with white knobs and red upward arrows, and blue downward arrows at the bottom.



OFF OFF ON OFF ON



P R N D







22.0°

Rear Comfort

Screen Off

22.0°

Control interface for Rear Comfort. It features two vertical sliders on the left and right for temperature adjustment, both currently set to 22.0°. The central area contains a diagram of a person sitting, with blue and green arrows indicating airflow from the seat. Above the diagram is a 'Rear Lock' button with a lock icon. Below the diagram are three directional buttons: a right arrow, a down arrow, and a left arrow. At the bottom, there is a row of buttons: 'Sync', 'Off', '1' (with a flower icon), '2', '3', '4', '5', '6', '7', and 'Auto'.

230 V AC
150 W



12V DC

230 V AC
150 W



12V DC



AIRBAG

GRAND WAGONEER









⚠️ AIRBAG
No children or pets in the front passenger seat.
No alcohol consumption while driving.
No use of mobile phones while driving.





OFF

ON

OPEN



AUTO

CLOSE

TILT



VENT

DOWN

OPEN



AUTO

CLOSE



UP

(P)68480338AA



®





McIntosh







AUTO

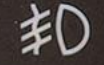









McIntosh



-

+

ADJUST

1

2













OP:810 SEQ:309930
P5530386 68480338AA









GRAND WAGONEER



GRAND WAGONEER



GR

SCORPION VERDE SEASON
EQUIPPT H 121 N

285/45 R22
285/45 R22 114H M+S

WAGNER





لمشاهدة صورة السيارة بزاوية 360 درجة إضغط على الصورة أعلاه

Для просмотра автомобиля в формате 360°, пожалуйста, нажмите на фото выше.

To view the 360° degree please press on the picture above

THE ALL-NEW

GRAND WAGONEER

جراند واجونير

الجديدة كليا



AUTOMAXX®



لمشاهدة الفيديو اضغط على الصورة أعلاه

To watch the video please press on the picture above

Для просмотра видео, пожалуйста, нажмите на изображение выше

2023 JEEP GRAND WAGONEER SERIES III 16 3.0L TT 4X4 GCC 0Km

Бренд: Jeep

Brand: Jeep

الماركة: جيب

Категория: GRAND WAGONEER

Category: GRAND WAGONEER

الفئة: GRAND WAGONEER

Модель: SERIES III LUXURY

Model: SERIES III LUXURY

الموديل: SERIES III LUXURY

Год: 2023

Year: 2023

السنة: 2023

Километров: 0 Km

Kilometers: 0 Km

كيلومترات: 0 كم

Двери: 4 Doors

Doors: 4 Doors

عدد الأبواب: 4 أبواب

Цвет: River Rock / Blue Agave

Color: River Rock / Blue Agave

اللون: River Rock / Blue Agave

Цилиндр: 6

Cylinder: 6 Cylinders

عدد الأسطوانات: 6 أسطوانات

Лошадиные силы: 510 HP

Horsepower: 510 HP

عدد الأحصنة: 510 حصان

Трансмиссия: Автоматическая

Transmission: Automatic

نوع النقل: نقل أوتوماتيكي

Топливо: Бензин

Fuel: Gasoline

نوع الوقود: بنزين

4X4

4X4

4X4

GCC

المواصفات خليجية

2023 JEEP GRAND WAGONEER SERIES III 16 3.0L TT 4X4 GCC 0Km

PREM LEATHER TRIMMED BUCKET SEATS

BLUE AGAVE

MIDDLE EAST EQUIPMENT GROUP

TECHNOLOGY GROUP III

FLEXIBLE SEATING GROUP

AUX BATTERY

40/20/40 2ND ROW BENCH PWR TIP/SLIDE

REMOVABLE ASH TRAY

8 PASSENGER SEATING

8-SPD AUTO 8HP75 TRANS (BUY-US)

3.0L 16 HURRICANE HO TWIN TURBO ESS

AUTO DIM EXTERIOR DRIVER MIRROR

CIGAR LIGHTER

130 MPH MAXIMUM SPEED CALIBRATION

GPS NAVIGATION

GPS ANTENNA INPUT

ACTIVE NOISE CONTROL SYSTEM

EXT. MIRRORS W/SUPPLEMENTAL SIGNALS

EXTERIOR MIRRORS W/ARABIC LETTERING

EXTERIOR MIRRORS W/MEMORY

AUTO ADJUST IN REVERSE EXT MIRRORS

HEATED EXTERIOR MIRRORS

EXTERIOR MIRRORS APPROACH LAMPS

BLACK ROOF

QUADRA DRIVE II BADGE

U.S. EMISSIONS W/OBD I

RIVER ROCK

ALL RADIO EQUIPPED VEHICLES

12.0" TOUCHSCREEN DISPLAY

2ND ROW DUAL CHG-ONLY USB PORTS

DIGITAL AUDIO BROADCASTING

ALL R1 HIGH RADIOS

PIRELLI BRAND TIRES

ALL ALUMINUM WHEELS

STOP-START DUAL BATTERY SYSTEM

ARABIC LANGUAGE

NIGHT VISION/PED-ANIMAL DETECTION

AMAZON FIRE TV BUILT-IN

10 ADDITIONAL GALLONS OF GAS

2023 JEEP GRAND WAGONEER SERIES III 16 3.0L TT 4X4 GCS OKm

Quadra Drive II

8 местный

Зимний Пакет

Gear Limit

Ночное видение

Вентиляция Сидений

Подогрев Сидений

Сиденья с функцией массажа

Рулевое Колесо с Подогревом

Регулируемые Сиденья с Памятью Положений

Дистанционный Запуск Двигателя

Система Мониторинга Слепых Зон

Бесключевой Доступ

Регулировка Режимов Вождения

режим Зимней Езды

Подрулевые Лепестки

Пневмоподвеска

Дистанционное управление пневмоподвеской

Адаптивный Круиз-контроль

ДИСПЛЕЙ ДЛЯ ПАССАЖИРА

Мультимедийная Система для Пассажиров Заднего Ряда

Камера Наблюдения Внутри Салона

Планшет для задних пассажиров

Ограничитель передач

Холодильник

Контурная Подсветка Салона

Боковые подножки

Система Экстренного Торможения

Контроль Полосы Движения

Ограничитель Скорости

Проекция на лобовое стекло

MCINTOSH Премиальная Мультимедийная Система С

23-МИ ДИНАМИКАМИ

Камера 360 Градусов

Панорамная Крыша

Беспроводная Зарядка

Система Помощи При Спуске с Горы

Датчик Давления в Шинах

Розетка

Задние Шторки

Система «Старт-Стоп»

Выдвижная Боковая Подножка

Автопарковка

Apple Carplay & Android Auto

2023 JEEP GRAND WAGONEER SERIES III 16 3.0L TT 4X4 GCC OKm

* الأداء:

ناقل حركة أوتوماتيكي ب 8 سرعات

عدد الأسطوانات: 6 أسطوانات

سعة المحرك: 3.0 ليتر

العزم: 677 نيوتن.متر

عدد الأحصنة: 510 حصان

دفع رباعي 4X4

* المواصفات الإضافية:

Quadra Drive II

8 مراتب

نظام الرؤية الليلية NIGHT VISION

كاميرا بزاوية 360 درجة

شاشة بروجكتر أمامي

شاشة إضافية للمرافق

شاشات خلفية

شاشة تحكم بالمقصورة الخلفية

ثلاجة أمامية

مثبت السرعة التكيفي

نظام الهيدروليك لرفع و خفض المركبة مع خاصية التحكم عن بعد

نظام صوتي متقدم من MCINTOSH مع 23 سماعة

خاصية التبريد للمراتب

خاصية التدفئة للمراتب

خاصية المساج المتقدم للمراتب

فتحة سقف بانوراما مزدوجة

2023 JEEP GRAND WAGONEER SERIES III 16 3.0L TT 4X4 GCC 0Km

خاصية الكشف عن النقطة العمياء
أوتوبارك
التشغيل عن بعد
دخول بصمة
عداد ديجيتال
خاصية تدفئة المقود
خاصية المساعدة في نزول المنحدرات
نظام البطارية المزدوجة للبدء والتوقف
كاميرا للمرآة الداخلية
محدد سرعة إلكتروني
نظام مكابح متقدم مع الفرامل التلقائية
الوضعيات المتعددة للقيادة
مراتب متعددة الوضعيات مع خاصية الذاكرة
وحدة تكييف خلفية منفصلة
جهاز تحكم بالشاشات عن بعد

خاصية تثبيت المسار
Gear Limit
كاميرا داخلية بزوايا 180 درجة
نظام الملاحة وتحديد المواقع
ابل كاربلاي لاسلكي
اندرويد أوتو لاسلكي
آمر صوتي متكامل مع بلوتوث
إنارة داخلية محيطيه
خاصية تنظيف الكاميرات
دبّة كهرباء مع حساس قدم
مخارج طاقة كهربائية متعددة
شاحن هاتف لاسلكي
ستائر خلفية
عزل حراري للزجاج الخارجي
عتبات جانبية كهربائية

AUTOMAX®

The Boutique Of Muscle Cars, Truck Fanatics & German Automotive Experts.



تتکلم اللغة العربية

WE SPEAK ENGLISH

ON PARLE LE FRANCAIS

Nosotros hablamos español

мы говорим по-русски

biz o'zbek tilida

gaplashamiz

हम हिंदी बोलते हैं



automaxgroup.me



[automax group](https://www.youtube.com/automaxgroup)



[automax.dxb](https://www.snapchat.com/add/automax.dxb)



[Automax_LLC](https://www.telegram.com/Automax_LLC)



[+971 50 602 7200](https://www.whatsapp.com/+971506027200)



[automax.dxb](https://www.instagram.com/automax.dxb)



[automax.dxb](https://www.facebook.com/automax.dxb)



[automax.dxb](https://www.tiktok.com/automax.dxb)



[automax_dxb](https://www.twitter.com/automax_dxb)



[automax group L.L.C](https://www.linkedin.com/company/automax-group-l-l-c)

New Auto Market - Dubai - United Arab Emirates

[Directions](#)