



WAGONEER

GRAND WAGONEER

AUTOMAX
AUTOMAX 4x4 3.0 CRD



RANGE ROVER

AUTOMAX
AUTOMAX KSA 011-55555555 050 277 277



GRAND WAGONEER

AUTOMAX
AUTOMAX 3.0 3.0 3.0 3.0 3.0



GRAND WAGONEER

AUTOMAX
AUTOMAX SA 2020 MA 077 27 F



GRAND WAGONEER



GRAND WAGONEER



GRAND WAGONEER





GRAND WAGONEER

0 km/h P 26°C
Key Fob
has Left
the Vehicle

DO NOT PRESS

Top View

3

START
ENGINE
STOP

Front
Lumbar
Up/Down
Lumbar
In/Out
Back
Bolster

GEAR
LIMIT



GRAND WAGONEER

AIRBAG

GRAND WAGONEER

AIRBAG
10

	SET+	
	CANC 	RES
	SET-	

+
GEAR

ON
OFF
REAR WASH



0
km/h

ULTONMAXX





1. Driver Info

0

MPH

P

29°C

S



Night Vision



GRAND WAGONER



معلومات السائق 1.

0

MPH

P

29°



Night Vision

61 km

H



C

F

E

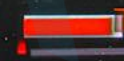

Check entire surroundings



Top View

Rear View

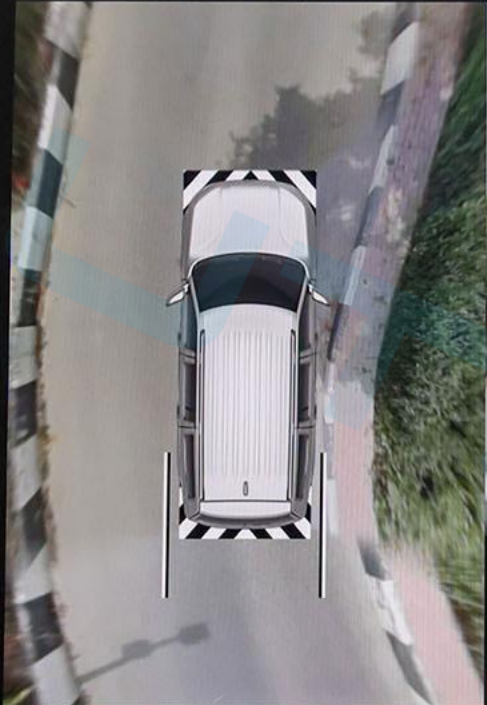

MAX REAR OFF AUTO A/C

Select a seat to change zoom view



A row of physical control buttons at the bottom of the screen. From left to right: a blue downward arrow, a red upward arrow, a 'MAX' button with a fan icon, a 'REAR' button with a car icon, a 'OFF' button with a fan icon, an 'AUTO' button, an 'A/C' button, a car icon with a red exclamation mark, and a blue upward arrow.

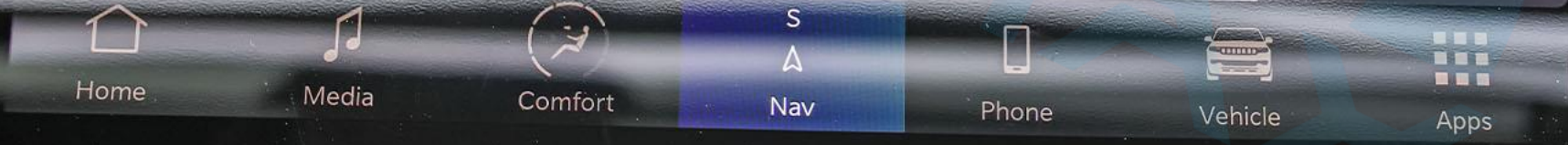
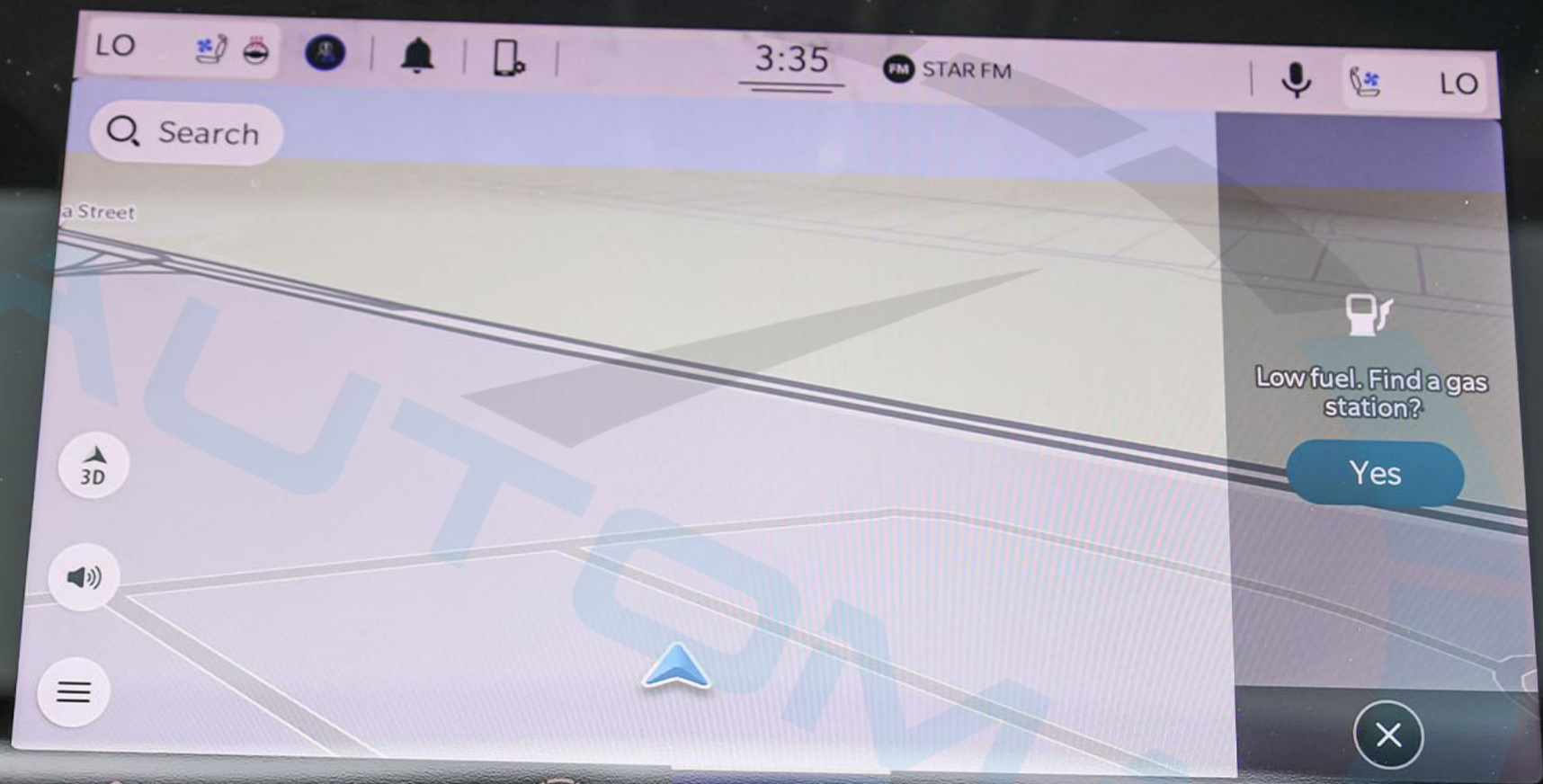

Front Seats Massage Rear

Heat Front Defrost Heat Vent

Max A/C A/C Max Rear

Sync Off < 1 2 3 4 5 6 7 > Auto

ZONE

[Icons]

ZONE

[Icons]

VOL

[Knob]

TUNE/SCROLL

[Knob]

LO



3:34

FM STAR FM



LO

Vehicle Dynamics

Steering Angle:
0°

Transfer Case:
Unlocked

Rear Axle Locker:
Unlocked

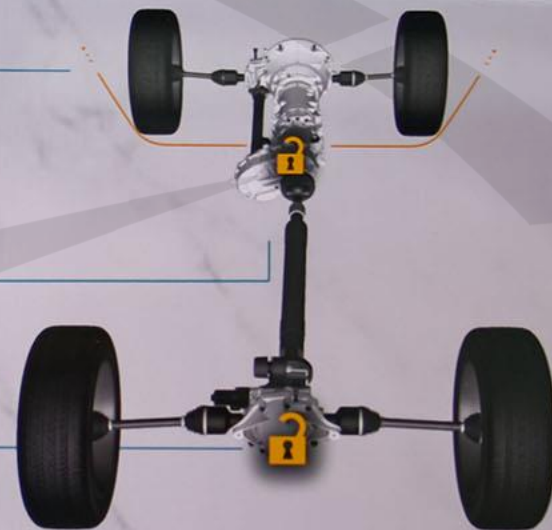

Accessory Gauges

Pitch & Roll

Selec-Terrain

Suspension

4WD
HIGH

55°22'35" E

25°10'04" N

Altitude -24 m

AUTO



Home



Media



Comfort



Nav



Phone



Vehicle



Apps



TUNE/
SCROLL

Vehicle Dynamics

Accessory Gauges

Pitch & Roll

Selec-Terrain

Suspension



4WD HIGH 55°22'35" E 25°10'04" N Altitude -24 m AUTO

Home

Media

Comfort

Nav

Phone

Vehicle

Apps

TUNE/SCROLL

- Vehicle Dynamics
- Accessory Gauges
- Pitch & Roll**
- Selec-Terrain
- Suspension



1°

Pitch



1°

Roll

4WD HIGH 55°22'35" E 25°10'04" N Altitude -24 m AUTO

VOL

TUNE/SCROLL

Vehicle Dynamics

Accessory Gauges

Pitch & Roll

Selec-Terrain

Suspension

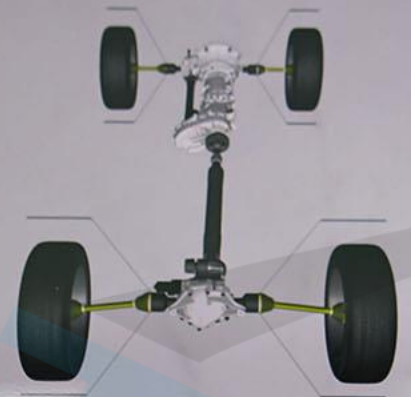

OFF RD 1

4WD HIGH

55°22'35" E

25°10'04" N

Altitude -24 m

AUTO



Home

Media

Comfort

Nav

Phone

Vehicle

Apps



AUTO

A/C



Vehicle Dynamics

Accessory Gauges

Pitch & Roll

Selec-Terrain

Suspension



4WD HIGH 55°22'35" E 25°10'04" N Altitude -24 m AUTO



Home

Media

Comfort

Nav

Phone

Vehicle

Apps



McIntosh

REFERENCE

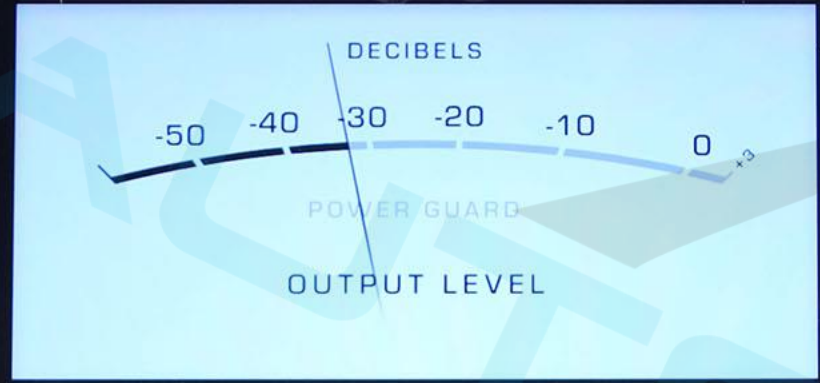

STAR FM

SMS: 3665 Phone: 600551211 twitter: @StarFMUAE insta...
99.9 FM

FM Radio

Audio

◀ CH

CH ▶

VOL

Home

Media

Comfort

Nav

Phone

Vehicle

Apps

TUNE/SCROLL

Favorites Recent Categories All

A-Z Z-A

☆
Tutorials

☆
Uconnect Theater

☆
USB 1

☆
USB 2

☆
Vehicle

☆
2nd Row Headrest...

☆
3rd Row Headrest...



LO

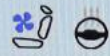

3:37

FM STAR FM



LO

Favorites

Recent

Categories

All

A-Z

Z-A



AM Radio



Ambient Color



Android Auto



Audio Settings



Auxiliary Cable



Bluetooth



Comfort

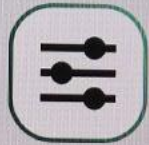

Controls



Home



Media



Comfort



Nav



Phone



Vehicle



Apps



LO



3:37

FM STAR FM



LO

Favorites

Recent

Categories

All

A - Z

Z - A



Tutorials



Uconnect Theater



USB 1



USB 2



Vehicle



2nd Row Headrest...



3rd Row Headrest...



Home



Media



Comfort



Nav



Phone



Vehicle



Apps



MAX

REAR



AUTO

AC



LO



3:37

FM STAR FM



LO



Selectable Tire Fill Alert



65.5



65.5



Apply and Save Preset

65.5

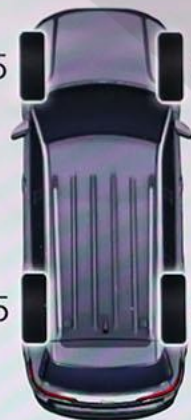

65.5

65.5

65.5

Presets



Home



Media



Comfort



Nav



Phone



Vehicle



Apps





VOL



TUNE/SCROLL



Topographic

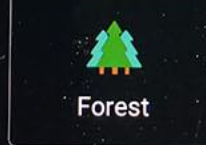

Forest



Fireplace



Aurora



Aquarium

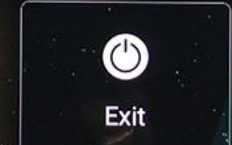

Exit



Front Seats Massage Rear Seats Off



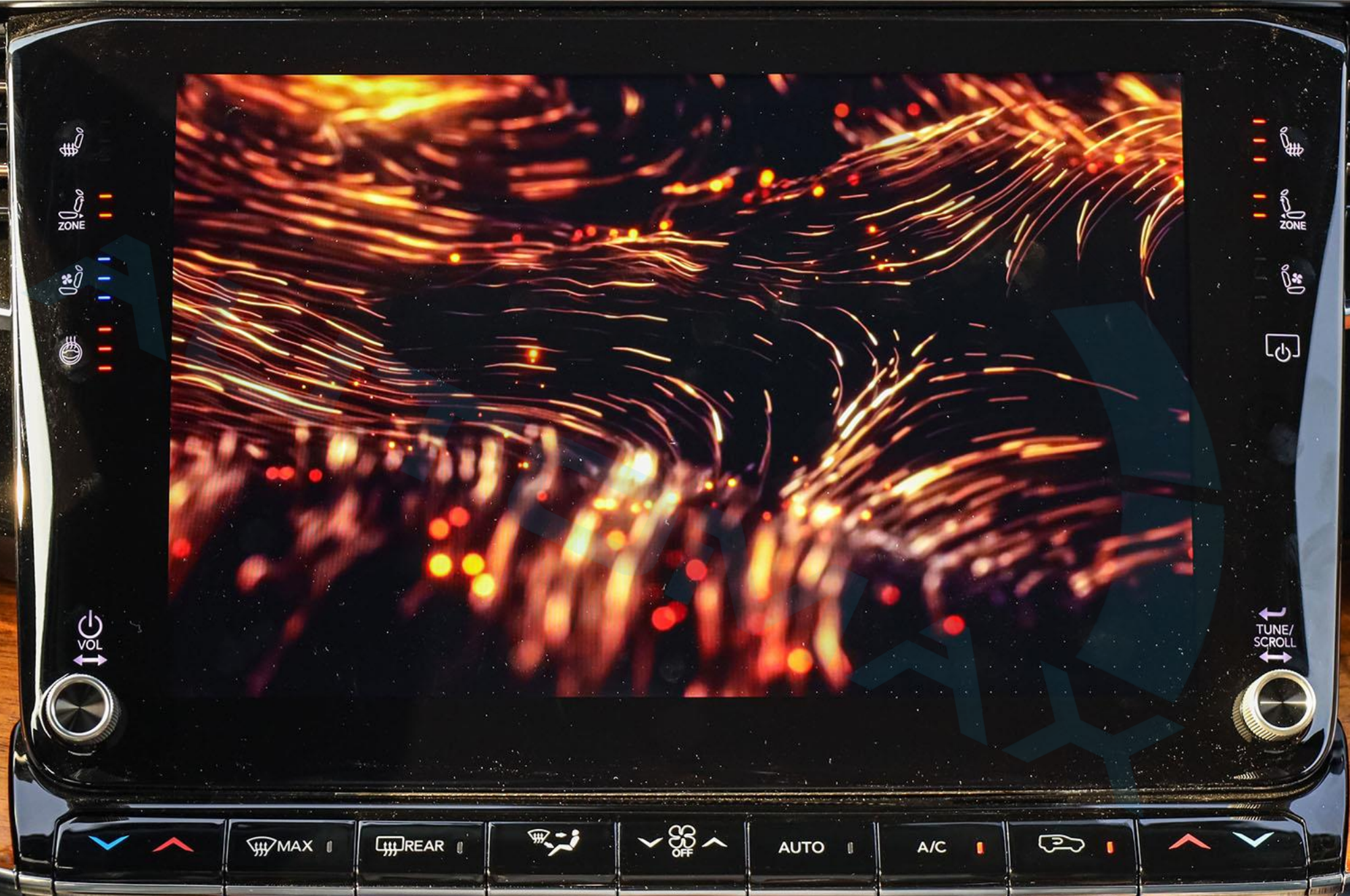

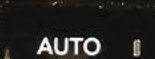

Передн. Сиденья Массаж Задний

Vertical slider with up and down arrows and a central square knob.

Пер. обдув

Об.

Вен

Макс. А/С

A/C

Максим.

Задний

Vertical slider with up and down arrows and a central square knob.

Синхр. Off < 1 2 3 4 5 6 7 > Авт.

VOL [Volume knob]

Главная

М/мед

Comfort

Nav

Тел.

Автом.

Прил.

TUNE/SCROLL [Tune/Scroll knob]

Низ.

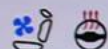

3:43

FM STAR FM



Низ.

Передн.

Сиденья

Массаж

Задний

Расслабл.

Расслабл.

Низ
спины

Гром.

Гром.

Низ
спины

Растягив.

Сред.

Сред.

Растягив.

Низ
растягив.

Низ.

Низ.

Низ
растягив.

Off

Off

Энергичный

Водит.

Пассаж.

Энергичный

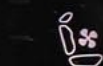

Главная



М/мед



Comfort



Nav



Тел.



Автом.



Прил.



TUNE/
SCROLL

Бездорожье

Элементы управления

Настройки

Затем.зер.
зад.вида

Склад.
подгол.
2 ряда

Склад.
подгол.
3 ряда

Экран
пассажира
Выкл.

Экран
пассажира
Питание
выкл.

Отказать в
выдаче
полномочи
й
экрану

Power
Side Step

Кам.круг.
обзора

FamCam

VOL

Главная

М/мед

Comfort

Nav

Тел.

Автом.

Прил.

TUNE/
SCROLL

MAX | REAR | OFF | AUTO | A/C |

Низ.



3:42

FM STAR FM



Низ.

Избранные

Последние

Категории

Все



Off Road Pages



Device Manager



Android Auto



VOL



Главная



М/мед



Comfort



Nav



Тел.



Автом.



Прил.

TUNE/SCROLL

Низ.

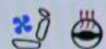

3:42

FM STAR FM



Низ.

Динамика
автомобиля

Вспомог.
приборы

Попер.
перемещения

Selec-Terrain

Подвески

Угол поворота
рулевого колеса:
0°

Раздаточная
коробка:
Разблокирована

Блокиратор
заднего моста:
Разблокирована

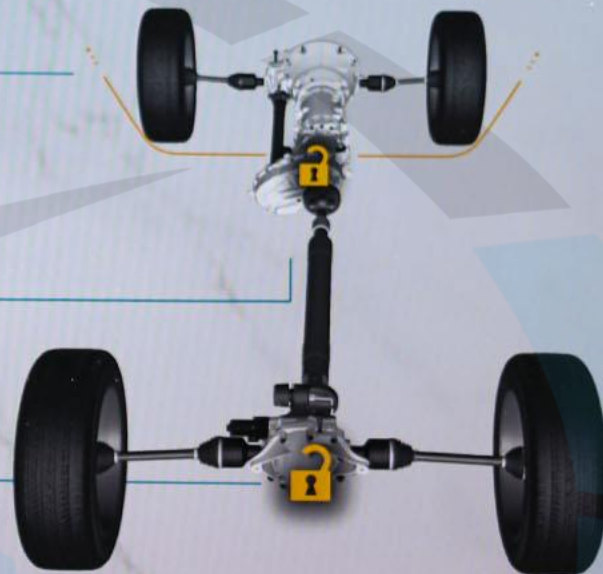

4WD
HIGH

55°22'35" В

25°10'04" С

Высота -24 м

AUTO



Главная



М/мед



Comfort



Nav



Тел.



Автом.



Прил.



TUNE/
SCROLL

- Динамика автомобиля
- Вспомог. приборы
- Попер. перемещения
- Selec-Terrain
- Подвески

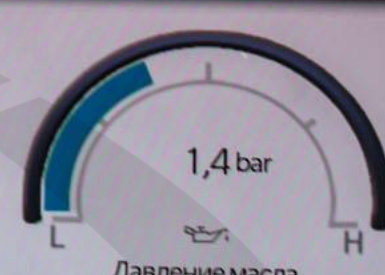

4WD HIGH 55°22'35" В 25°10'04" С Высота -24 m AUTO

Главная М/мед Comfort Ю А Nav Тел. **Автом.** Прил.

MAX REAR OFF AUTO A/C

Низ.



3:42

FM STAR FM



Низ.

Динамика
автомобиля

Вспомог.
приборы

Попер.
перемещения

Selec-Terrain

Подвески



1°

Наклон



1°

Крен

4WD
HIGH

55°22'35" В

25°10'04" С

Высота -24 м

AUTO



Главная



М/мед



Comfort



Nav



Тел.



Автом.



Прил.

TUNE/
SCROLL



Динамика автомобиля

Вспомог. приборы

Попер. перемещения

Selec-Terrain

Подвески



4WD HIGH 55°22'35" В 25°10'04" С Высота -24 m AUTO

VPL

Главная

М/мед

Comfort

Ю
▲
Nav

Тел.

Автом.

Прил.

TUNE/SCROLL

Низ. | 3:42 | FM STAR FM | Низ.

Динамика автомобиля

Вспомог. приборы

Попер. перемещения

Selec-Terrain

Подвески

4WD HIGH 55°22'35" В 25°10'04" С Высота -24 m AUTO

OFF RD 1

VOL

Главная М/мед Comfort Ю А Nav Тел. Автом. Прил.

TUNE/SCROLL

MAX REAR OFF AUTO A/C

Низ.



3:42

FM STAR FM



Низ.

Ambient Color Personalization

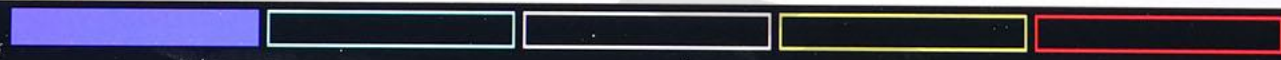

Син.

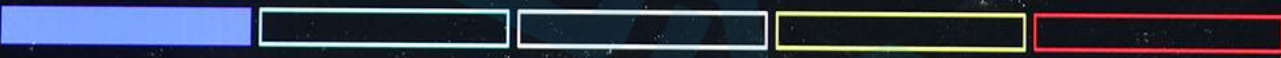

Главная

М/мед

Comfort

Ю
A
Nav

Тел.

Автом.

Прил.



الأمامي المقاعد تدليك خلفي

إزالة الصقيع الأمامي

تسخين مقود التوجيه عالية

تبريد

تسخين تبريد

أقصى تكييف

تكييف الماء

حد أقصى

خلفي

مزامنة Off < 1 2 3 4 5 6 7 > ألي

مكشوف

ZONE

مكشوف

مكشوف

مكشوف

ZONE

مكشوف

مكشوف

مكشوف

VOL

التطبيقات

المركبة

الهاتف

S A Nav

Comfort

الوسائط

الرئيسية

TUNE/SCROLL

MAX REAR [Icons] AUTO A/C [Icons]

LO



٣:٤١

STAR FM

FM



LO

الأمامي

المقاعد

تدليك

خلفي

الاسترخاء

الاسترخاء

أسفل
الظهرأسفل
الظهر

تمديد

تمديد

تمديد أسفل
الظهرتمديد أسفل
الظهر

شديد

شديد

عالي

عالي

متوسط

متوسط

منخفض

منخفض

Off

Off



السائق



الراكب



التطبيقات



المركبة



الهاتف

S

Nav



Comfort



الوسائط



الرئيسية

TUNE/
SCROLLTUNE/
SCROLL

LO



٣:٣٩

STAR FM FM



LO

ديناميكيات
المركبة

ملحقات
المقاييس

انحدار و
التفاف

Selec-Terrain

نظام التعليق

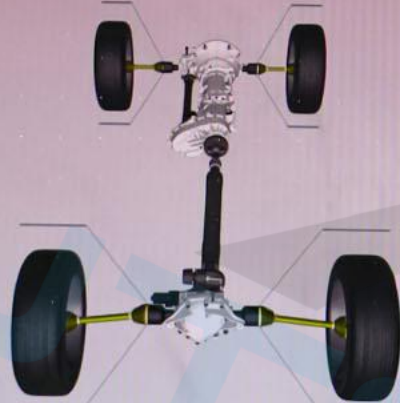

OFF RD 1

4WD
HIGH

55°22'35" E

25°10'04" N

ارتفاع -24m

AUTO

التطبيقات

المركبة

الهاتف

S
A
Nav

Comfort

الوسائط

الرئيسية

TUNE/
SCROLL



LO



٣:٣٩

STAR FM



LO

ديناميكيات
المركبة

ملحقات
المقاييس

انحدار و
التفاف

Selec-Terrain

نظام التعليق



4WD
HIGH

55°22'35" E

25°10'04" N

ارتفاع -24 m

AUTO

التطبيقات

المركبة

الهاتف

Nav

Comfort

الوسائط

الرئيسية

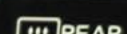

AUTO

A/C



ديناميكيات
المركبة

ملحقات
المقاييس

انحدار و
التفاف

Selec-Terrain

نظام التعليق



1°

انحدار

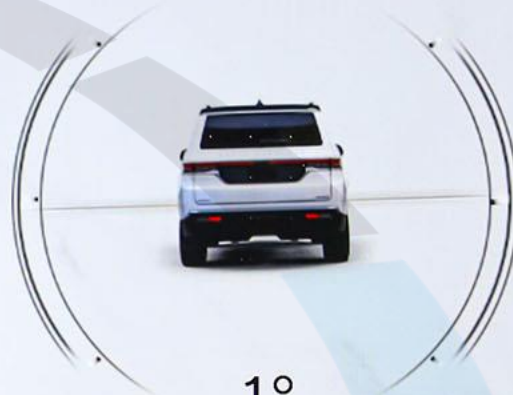

1°

التفاف

4WD
HIGH

55°22'35" E

25°10'04" N

ارتفاع -24 m

AUTO

التطبيقات

المركبة

الهاتف

Nav

Comfort

الوسائط

الرئيسية

VOL

TUNE/SCROLL

LO



٣:٣٩

STAR FM FM



LO

ديناميكيات
المركبة

ملحقات
المقاييس

انحدار و
التفاف

Selec-Terrain

نظام التعليق

4WD
HIGH

55°22'35" E

25°10'04" N

ارتفاع -24 m

AUTO

VOL



التطبيقات



المركبة



الهاتف



Nav



Comfort



الوسائط



الرئيسية

TUNE/
SCROLL



الجميع الفئات الأخيرة المفضلة

ي-ا ي-ا

☆  طبي مسند رأس... ☆  طبي مسند رأس... ☆  FM راديو	☆  AM راديو
☆  لون المحيط الداخلي ☆  كاميرا الرؤية المحيطة ☆  كاميرا الرؤية الخلفية ☆  AUX كابل	

التطبيقات المركبة الهاتف Nav Comfort الوسائط الرئيسية

VOL [Knob]

TUNE/SCROLL [Knob]

MAX REAR OFF AUTO A/C [Icons]

ديناميكيات
المركبة

ملحقات
المقاييس

انحدار و
التفاف

Selec-Terrain

نظام التعليق

زاوية التوجيه:
0°

حالة النقل:
غير مغلق

قفل المحور
الخلفي:
غير مغلق

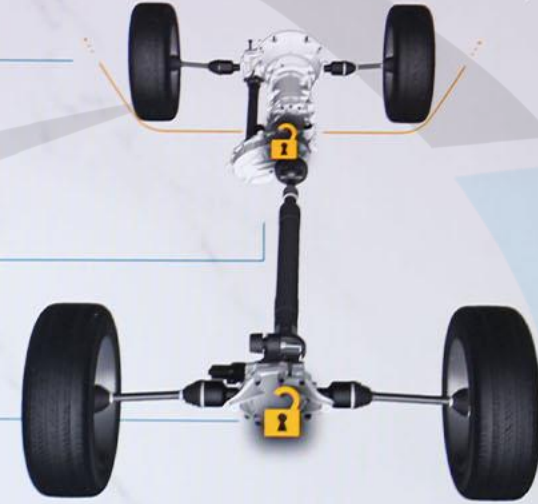

4WD
HIGH

55°22'35" E 25°10'04" N

ارتفاع -24 m

AUTO

VOL

التطبيقات

المركبة

الهاتف

S
A
Nav

Comfort

الوسائط

الرئيسية

TUNE/
SCROLL

LO



٣:٣٨

STAR FM FM



LO

أراض وعرة

متحكمات

إعدادات

طي مسند
الرأس للصف
الثالث



طي مسند
الرأس للصف
الثاني



معتم المرأة



منع أذونات
شاشة
الراكب



إيقاف
تشغيل
شاشة
الراكب



شاشة
الراكب
مطفأة



FamCam



كاميرا الرؤية
المحيطة



Power Side
Step



التطبيقات

المركبة

الهاتف

S
A
Nav

Comfort

الوسائط

الرئيسية



TUNE/
SCROLL



MAX

REAR



OFF

AUTO

A/C



الجميع الفئات الأخيرة المفضلة

ي-١ ي-١

☆ هاتف	☆ ملفات تعريف...	☆ مقود مدفأ	☆ مقاعد التدليك
☆ Device Manager	☆ DAB	☆ Bluetooth	☆ Android Auto

VOL

TUNE/SCROLL

LO



Off Road



Mirror Dimmer

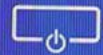

Pass Screen Off

Power Side



|   LO

Settings

rd Row
eadrest
old

eny Pass
creen
ermissions

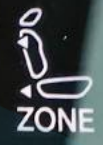

LO [Icons] ٣:٣٩ STAR FM [FM] [Icons] LO

Ambient Color Personalization >

ZONE [Icons]

ZONE [Icons]



مزامنة

[VOL] [Icons]

التطبيقات

المركبة

الهاتف

Nav

Comfort

الوسائط

الرئيسية

[TUNE/SCROLL] [Icons]



GRAND WAGON

System



Screen Off



Power Off

Controls

Home



Controls

System

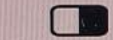

Screen Off



Power Off



Wireless Headphones



Manage Headphone



Mute



Navigation and climate control buttons:

Front Seats | Message | Rear | Screen Off

	Lumbar Up/Down		
	Back Bolster		
	Thigh Bolster		

Driver | Passenger

Drive mode and vehicle control buttons:

ROCK SAND/MUD SNOW AUTO SPORT

4WD LOW

PRND

4N



Front Seats Massage Rear Screen Off

Lumbar Up/Down

Lumbar In/Out

Back Bolster

Thigh Bolster



Driver



Passenger

Lumbar Up/Down

Lumbar In/Out

Back Bolster

Thigh Bolster





Front Seats Massage Rear Screen Off

Waterfall	High			High	Waterfall
Lower Back	Med			Med	Lower Back
Extend	Low			Low	Extend
Low Extend	Off			Off	Low Extend
Rock Climb					Rock Climb

Driver Passenger



ROCK

P R N D



LO Front Seats Massage Rear Screen Off LO

Front Defrost

→

↘

Sync Off 1 2 3 4 5 6 7 Max A/C

A digital climate control interface on a touchscreen. The interface is divided into sections: 'Front', 'Seats', 'Massage', 'Rear', and 'Screen Off'. The 'Front' section is active, showing a 'Front Defrost' button with a wiper icon, a blue arrow button pointing right, and a blue arrow button pointing down-right. A central graphic shows a driver's silhouette with blue and green light beams representing airflow. On the left and right sides, there are vertical sliders with white knobs and red upward arrows, and blue downward arrows at the bottom. At the bottom of the screen, there is a row of buttons: 'Sync', 'Off', and a numbered row from 1 to 7. The number 5 is highlighted in blue and has a fan icon next to it. The last button is 'Max A/C'.

OFF OFF ON OFF ON



TOW/HAUL ON



P R N D





22.0° Rear Comfort Screen Off 22.0°

The interface features a central graphic of a person sitting in a car seat, with blue and green waves representing airflow. To the left and right of this graphic are vertical sliders for temperature control, each with a white knob and a purple-to-white gradient bar. Above the central graphic are three icons: a fan, a right-pointing arrow, and a downward-pointing arrow. Below the central graphic is a row of buttons: 'Sync', 'Off', '1' (with a four-leaf clover icon), '2', '3', '4', '5', '6', '7', and 'Auto'. The '1' button is currently selected and highlighted in blue.

230 V AC
150 W



12V DC

230 V AC
150 W



12V DC



AIRBAG

GRAND WAGONEER













OFF

ON

OPEN



AUTO

CLOSE

TILT



VENT

DOWN

OPEN



AUTO

CLOSE



UP

(P)68480338AA



®











AUTO



PULL ON





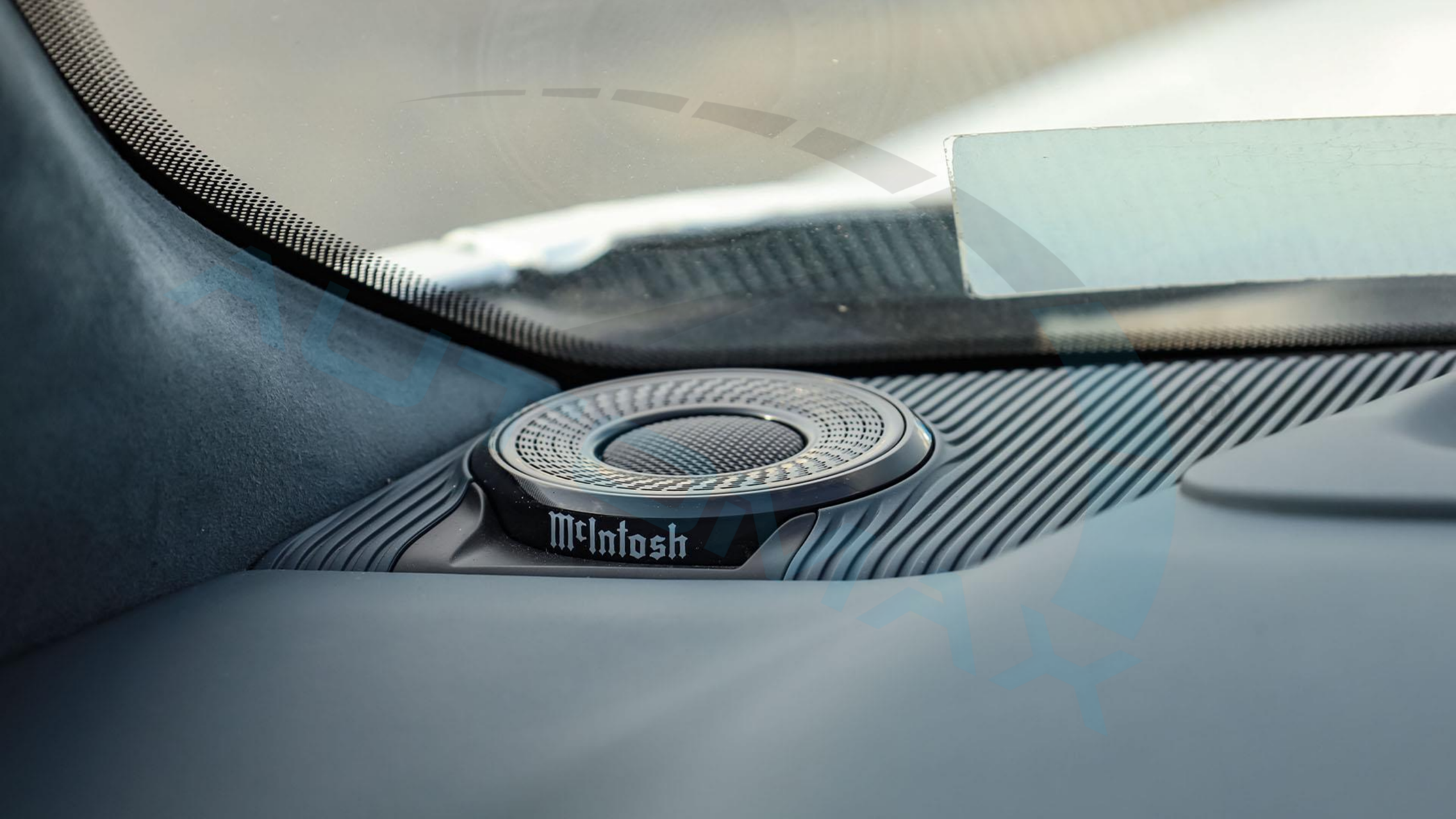

McIntosh





Control panel with buttons and a speaker. The word "ADJUST" is visible on the panel.

Control panel with buttons and a knob. The buttons are labeled "MEMO", "AUTO", and "OFF".

Speaker grille with the McIntosh logo.



ADJUST

1

2



McIntosh





ALFA ROMEO

®







GRAND WAGONEER



QUADRA DRIVE II



S E R I E S



GRAND WAGONEER



285/45 R22

VERDE
ALL SEASON

SCORPION

WAGONEER





لمشاهدة صورة السيارة بزاوية 360 درجة إضغط على الصورة أعلاه

Для просмотра автомобиля в формате 360°, пожалуйста, нажмите на фото выше.

To view the 360° degree please press on the picture above

THE ALL-NEW

GRAND WAGONEER

جراند واجونير

الجديدة كليا



AUTOMAXX®



لمشاهدة الفيديو اضغط على الصورة أعلاه

To watch the video please press on the picture above

Для просмотра видео, пожалуйста, нажмите на изображение выше

2023 JEEP GRAND WAGONEER SERIES III 16 3.0L TT 4X4 GCC 0Km

Бренд: Jeep

Brand: Jeep

الماركة: جيب

Категория: GRAND WAGONEER

Category: GRAND WAGONEER

الفئة: GRAND WAGONEER

Модель: SERIES III LUXURY

Model: SERIES III LUXURY

الموديل: SERIES III LUXURY

Год: 2023

Year: 2023

السنة: 2023

Километров: 0 Km

Kilometers: 0 Km

كيلومترات: 0 كم

Двери: 4 Doors

Doors: 4 Doors

عدد الأبواب: 4 أبواب

Цвет: Белый

Color: Bright White / Blue Agave

اللون: أبيض

Цилиндр: 6

Cylinder: 6 Cylinders

عدد الأسطوانات: 6 أسطوانات

Лошадиные силы: 510 HP

Horsepower: 510 HP

عدد الأحصنة: 510 حصان

Трансмиссия: Автоматическая

Transmission: Automatic

نوع النقل: نقل أوتوماتيكي

Топливо: Бензин

Fuel: Gasoline

نوع الوقود: بنزين

4X4

4X4

4X4

GCC

المواصفات خليجية

2023 JEEP GRAND WAGONEER SERIES III 16 3.0L TT 4X4 GCC 0Km

PREM LEATHER TRIMMED BUCKET SEATS

BLUE AGAVE

MIDDLE EAST EQUIPMENT GROUP

TECHNOLOGY GROUP III

FLEXIBLE SEATING GROUP

AUX BATTERY

40/20/40 2ND ROW BENCH PWR TIP/SLIDE

REMOVABLE ASH TRAY

8 PASSENGER SEATING

8-SPD AUTO 8HP75 TRANS (BUY-US)

3.0L 16 HURRICANE HO TWIN TURBO ESS

AUTO DIM EXTERIOR DRIVER MIRROR

CIGAR LIGHTER

130 MPH MAXIMUM SPEED CALIBRATION

GPS NAVIGATION

GPS ANTENNA INPUT

ACTIVE NOISE CONTROL SYSTEM

EXT. MIRRORS W/SUPPLEMENTAL SIGNALS

EXTERIOR MIRRORS W/ARABIC LETTERING

EXTERIOR MIRRORS W/MEMORY

AUTO ADJUST IN REVERSE EXT MIRRORS

HEATED EXTERIOR MIRRORS

EXTERIOR MIRRORS APPROACH LAMPS

BLACK ROOF

QUADRA DRIVE II BADGE

U.S. EMISSIONS W/OBD I

BRIGHT WHITE CLEAR COAT

ALL RADIO EQUIPPED VEHICLES

12.0" TOUCHSCREEN DISPLAY

2ND ROW DUAL CHG-ONLY USB PORTS

DIGITAL AUDIO BROADCASTING

ALL R1 HIGH RADIOS

PIRELLI BRAND TIRES

ALL ALUMINUM WHEELS

STOP-START DUAL BATTERY SYSTEM

ARABIC LANGUAGE

NIGHT VISION/PED-ANIMAL DETECTION

AMAZON FIRE TV BUILT-IN

10 ADDITIONAL GALLONS OF GAS

2023 JEEP GRAND WAGONEER SERIES III 16 3.0L TT 4X4 GCS OKm

Quadra Drive II

8 местный

Зимний Пакет

Gear Limit

Ночное видение

Вентиляция Сидений

Подогрев Сидений

Сиденья с функцией массажа

Рулевое Колесо с Подогревом

Регулируемые Сиденья с Памятью Положений

Дистанционный Запуск Двигателя

Система Мониторинга Слепых Зон

Бесключевой Доступ

Регулировка Режимов Вождения

режим Зимней Езды

Подрулевые Лепестки

Пневмоподвеска

Дистанционное управление пневмоподвеской

Адаптивный Круиз-контроль

ДИСПЛЕЙ ДЛЯ ПАССАЖИРА

Мультимедийная Система для Пассажиров Заднего Ряда

Камера Наблюдения Внутри Салона

Планшет для задних пассажиров

Ограничитель передач

Холодильник

Контурная Подсветка Салона

Боковые подножки

Система Экстренного Торможения

Контроль Полосы Движения

Ограничитель Скорости

Проекция на лобовое стекло

MCINTOSH Премиальная Мультимедийная Система С

23-МИ ДИНАМИКАМИ

Камера 360 Градусов

Панорамная Крыша

Беспроводная Зарядка

Система Помощи При Спуске с Горы

Датчик Давления в Шинах

Розетка

Задние Шторки

Система «Старт-Стоп»

Выдвижная Боковая Подножка

Автопарковка

Apple Carplay & Android Auto

2023 JEEP GRAND WAGONEER SERIES III 16 3.0L TT 4X4 GCC OKm

* الأداء:

ناقل حركة أوتوماتيكي ب 8 سرعات

عدد الأسطوانات: 6 أسطوانات

سعة المحرك: 3.0 ليتر

العزم: 677 نيوتن.متر

عدد الأحصنة: 510 حصان

دفع رباعي 4X4

* المواصفات الإضافية:

Quadra Drive II

8 مراتب

نظام الرؤية الليلية NIGHT VISION

كاميرا بزاوية 360 درجة

شاشة بروجكتر أمامي

شاشة إضافية للمرافق

شاشات خلفية

شاشة تحكم بالمقصورة الخلفية

ثلاجة أمامية

مثبت السرعة التكيفي

نظام الهيدروليك لرفع و خفض المركبة مع خاصية التحكم عن بعد

نظام صوتي متقدم من MCINTOSH مع 23 سماعة

خاصية التبريد للمراتب

خاصية التدفئة للمراتب

خاصية المساج المتقدم للمراتب

فتحة سقف بانوراما مزدوجة

2023 JEEP GRAND WAGONEER SERIES III 16 3.0L TT 4X4 GCC 0Km

خاصية الكشف عن النقطة العمياء
أوتوبارك
التشغيل عن بعد
دخول بصمة
عداد ديجيتال
خاصية تدفئة المقود
خاصية المساعدة في نزول المنحدرات
نظام البطارية المزدوجة للبدء والتوقف
كاميرا للمرآة الداخلية
محدد سرعة إلكتروني
نظام مكابح متقدم مع الفرامل التلقائية
الوضعيات المتعددة للقيادة
مراتب متعددة الوضعيات مع خاصية الذاكرة
وحدة تكييف خلفية منفصلة
جهاز تحكم بالشاشات عن بعد

خاصية تثبيت المسار
Gear Limit
كاميرا داخلية بزوايا 180 درجة
نظام الملاحة وتحديد المواقع
ابل كاربلاي لاسلكي
اندرويد أوتو لاسلكي
آمر صوتي متكامل مع بلوتوث
إنارة داخلية محيطيه
خاصية تنظيف الكاميرات
دبّة كهرباء مع حساس قدم
مخارج طاقة كهربائية متعددة
شاحن هاتف لاسلكي
ستائر خلفية
عزل حراري للزجاج الخارجي
عتبات جانبية كهربائية

AUTOMAX®

The Boutique Of Muscle Cars, Truck Fanatics & German Automotive Experts.



نتكلم اللغة العربية

WE SPEAK ENGLISH

ON PARLE LE FRANCAIS

Nosotros hablamos español

мы говорим по-русски

biz o'zbek tilida

gaplashamiz

हम हिंदी बोलते हैं



automaxgroup.me



[automax group](https://www.youtube.com/automaxgroup)



[automax.dxb](https://www.snapchat.com/add/automax.dxb)



[Automax_LLC](https://www.telegram.com/Automax_LLC)



[+971 50 602 7200](https://www.whatsapp.com/+971506027200)



[automax.dxb](https://www.instagram.com/automax.dxb)



[automax.dxb](https://www.facebook.com/automax.dxb)



[automax.dxb](https://www.tiktok.com/automax.dxb)



[automax_dxb](https://www.twitter.com/automax_dxb)



[automax group L.L.C](https://www.linkedin.com/company/automax-group-l-l-c)

New Auto Market - Dubai - United Arab Emirates

[Directions](#)